

Geräteschutzsicherungen

Miniature Fuses



*Sie profitieren. Mit Sicherheit.
Our Protection. Your Benefit.*

Klassische zylindrische Sicherungen mit oder ohne Farbkennzeichnung nach unterschiedlichsten Normen, Kleinst-Sicherungseinsätze, SMD-Technologie, Sonderbauformen – auch der vorliegende neue Katalog zeigt wieder das ganze Spektrum des SIBA-Geräteschutzprogramms. Unsere Sicherungen schützen in vielen Bereichen vor zu hohen Strömen: Ob IT oder Telekommunikation, Haushaltsgeräte oder Industrieanwendungen.

SIBA-Sicherungs-Know-how reicht aber weit über den Geräteschutz hinaus. Seit über 70 Jahren fertigen wir Schutzeinrichtungen für Hoch- und Niederspannung. Viele Energieversorger vertrauen unseren HH-Sicherungseinsätzen, sehr schnelle Ultra-Rapid-Einsätze sorgen dafür, dass empfindliche Leistungshalbleiter nicht beschädigt werden. Und eine Reihe von Industriekunden setzen auf Motor- und Maschinenschutz durch SIBA-NH-Sicherungen.

Welcher Einsatzbereich auch immer – Sicherungen sind auf den ersten Blick „nur“ C-Produkte. Aber es sind Investments in die Sicherheit von Menschen. Und in die Sicherheit von Produkten und Maschinen. Investments, die sich auszahlen, denn jeder Abschaltvorgang einer Sicherung spart Folge-Kosten. Das funktioniert aber nur mit verlässlicher Qualität. Standbein ist hier unser eigenes Forschungs- und Entwicklungslabor, das jedes Produkt auf Herz und Nieren testet – und dafür sorgt, dass über alle Einsatzgebiete hinweg Know-how ausgetauscht wird. Die enge Verzahnung mit der eigenen Produktion

am Stammsitz Lünen garantiert, dass unsere Produktversprechen auch im Alltag eingehalten werden. Ganz gleich, ob es um eine Hochspannungssicherung in einem deutschen Umspannwerk oder eine SMD-Sicherung in einer Industrieanwendung geht. Denn sowohl vom Stammsitz aus als auch von unseren elf Auslandsgesellschaften gehen SIBA-Sicherungen in alle Welt.

Damit auch Sie die richtige Geräteschutz-Sicherung finden, haben wir unseren neuen Katalog noch übersichtlicher gestaltet. Wie bisher schon helfen Ihnen außerdem allgemeine Hinweise und ein Flussdiagramm bei der Auswahl der geeigneten Sicherung. Das ist oft alles andere als einfach, denn je nach Einsatzort und -zweck reicht auch das detaillierteste Diagramm manchmal nicht aus. Aber dafür gibt es unsere Spezialisten, die Ihnen bei der Planung helfen – und im Extremfall unsere Produkte auch individuell anpassen. Sprechen Sie uns an, fordern Sie uns – wir freuen uns auf Sie!

Michael Schröer
Geschäftsführer

All-round current overload protection – from the SMD fuse to high voltage technology

Classical cylindrical fuses with or without colour markings to a wide variety of standards, microfuses, SMD technology, custom design – our new catalogue shows the whole spectrum of the SIBA equipment protection range. Our fuses provide overload protection in many sectors, from IT or telecommunications to household appliances to industrial applications.

SIBA fuse know-how, however, goes far beyond miniature fuses. We have been manufacturing high and low voltage protective devices for more than 70 years. Many energy suppliers place their confidence in our HH fuses and very fast ultra-rapid fuselinks make sure that sensitive power semiconductors are not damaged. Several industrial customers rely on motor and machine protection provided by SIBA NH fuses.

No matter how they are used, at first sight fuses are “only” C products. They are, nevertheless, investments in people’s safety. And in the safety of products and machinery. Investments that pay off, as every fuse shutdown saves follow-up costs. But this will only work with quality you can rely on. Here our main support is provided by our own research and development laboratory, where every product is rigorously put through its paces and where we see to it that know-

how is exchanged on all ranges of application. Close interlocking with our own production facility at our headquarters in Lünen guarantees that our promises on products are kept in everyday life. It does not matter at all whether we are talking about a high voltage fuse in a German electric power transformation substation or a SMD-fuse in a industrial application. SIBA fuses are shipped all over the world from our headquarters as well as from our eleven foreign subsidiaries.

In order that you too will be able to find the right miniature fuse, our new catalogue is even more clearly laid out. As previously, our general information and flowcharts will also help you select the right fuse. In many cases this is by no means an easy task; depending on the location and the purpose of the fuse application even the most detailed diagram may not suffice. This is where our specialists come in. They will help you with your planning – and in extreme cases they will individually arrange our products to suit your purposes. Contact us, challenge us – we look forward to hearing from you!

Michael Schröer
Managing director

Inhalt / Contents

Allgemeine Informationen / General Information

Produktübersicht / Product range	6
Technische Erläuterungen / Technical notes	8
Auswahldiagramm / Selection diagram	15

Kleinsteinsicherungen / Sub-miniature Fuses

Chip 0402, 0603, 0805, 1206	18
2,6 x 6,1 mm (SMD)	22
flink / quick acting	22
träge / time-lag	23
4,5 x 8 mm (SMD)	24
träge / time-lag	24
flink / quick acting	26
4,5 x 16 mm (SMD)	27
träge / time-lag	27
superträge / very time-lag	29
5,8 x 20 mm (SMD)	30
träge / time-lag	30
8,4 x 7,6 mm	31
flink / quick acting	31
mittelträge / medium time-lag	33
träge / time-lag	34

G-Sicherungseinsätze / Fuse-Links

5 x 20 mm	38
superflink / very quick acting	38
aR (FF)	40
flink / quick acting	42
mittelträge / medium time-lag	45
träge / time-lag	47
superträge / very time-lag	53
5 x 25 mm	55
flink / quick acting	55
mittelträge / medium time-lag	57
flink / quick acting	58
mittelträge / medium time-lag	57
flink / quick acting	58
5 x L mm	59
mittelträge / medium time-lag	59
5 x 30 mm	60
flink / quick acting + mittelträge / med. time-lag	60
6,3 x 32 mm	61
superflink / very quick acting	61
aR (FF)	62
gRL	63
flink / quick acting	64
träge / time-lag	67
gPV	70
8 x 40 mm	71
mittelträge / medium time-lag + flink / quick acting	71
8 x 65 mm	72
flink / quick acting	72
8 x 50 mm / 8 x 85 mm	73
mittelträge / medium time-lag + flink / quick acting	73
8 x 120 mm / 8 x 150 mm	74
mittelträge / medium time-lag + flink / quick acting	74
Weitere G-Hochspannungstypen / G-high voltage fuses	75

G-Sicherungshalter / Fuse-Holder

für Kleinsteinsicherungen / for Sub-miniature Fuses	78
für G-Sicherungseinsätze / for miniature Fuse-Links	78
offene Bauart für Hochspannungs-G-Sicherungseinsätze /	
Fuse-Holders open type for High-Voltage miniature Fuse-Links	93
weitere Halter für G-Hochspannungssicherungen / Holder for G-high voltage fuses	94

Ergänzende Angaben / Additional Notes

Typenvergleichsliste / Cross Reference List	97
---	----



Allgemeine Informationen / General Information

Technische Erläuterungen
(Begriffe, Normen, Basisdiagramme,
Sicherungs-Charakteristiken u.a.),
Hilfen zur Auswahl von Sicherungen

Technical Notes
(Terms, standards, basic diagrams,
characteristics, ...),
Selection guides

Produktübersicht / Product range

G-Sicherungseinsätze Fuse-Links								G-Sicherungshalter Fuse-Holders				
Type	Seite Page	RoHS	Abmessungen Dimensions	Bem. spannung Rated Voltage	Charak- teristik Charac- teristic	Bem.-Ausschalt- vermögen Rated Breaking Capacity	Normen Standards	für G-Sicherg. for Fuse-Links	Bem.- spannung Rated Voltage	Bem.- strom Rated Current	Montage Mounting	Kappe Cap
151000	18	◆	1,00 x 0,5 mm	32 V	FF	50 A DC	UL 248-14					
152000	19	◆	1,55 x 0,85 mm	32 V	FF	50 A DC						
153000	20	◆	2,00 x 1,25 mm	32 V	FF	50 A DC	UL 248-14 IEC 60127-4					
154000	21	◆	3,20 x 1,6 mm	63 V	FF	50 A DC						
157000	22	◆	2,6 x 6,1 mm	65 / 125 V	F	50 A AC / DC	UL 248-14					
158000	23	◆	2,6 x 6,1 mm	125 V	T	50 A AC / DC	UL 248-14					
160000	24	◆	4,5 x 8,0 mm	250 V	T	100 A AC	IEC 60127					
160500	25	◆	4,5 x 8,0 mm	250 V	T	100 A AC	IEC 60127					
160016	27	◆	4,5 x 16 mm	250 V	T	1500 A AC/DC	IEC 60127-4/2					
160516	28	◆	4,5 x 16 mm	250 V	T	1500 A AC/DC	IEC 60127-4/2					
160020	30	◆	5,8 x 20 mm	250 V	T	1500 A DC/AC	IEC 60127-7					
161000	26	◆	4,5 x 8,0 mm	250 V	F	100 A AC	IEC 60127-4					
163016	29	◆	4,5 x 16 mm	250	TT	35 A AC	IEC 60127-4					
164000	31	◆	8,4 x 7,6 mm	250 V	F	(35 A / 10 x I _{rat}) AC	IEC 60127-3/3					
164050	31	◆	8,4 x 7,6 mm	250 V	F	(35 A / 10 x I _{rat}) AC	IEC 60127-3/3					
164500	32	◆	8,4 x 7,6 mm	250 V	F	50 A AC	UL 248-14					
164550	32	◆	8,4 x 7,6 mm	250 V	F	50 A AC	UL 248-14					
165000	33	◆	8,4 x 7,6 mm	250 V	M	(35 A / 10 x I _{rat}) AC	(IEC 60127-3)					
165050	33	◆	8,4 x 7,6 mm	250 V	M	(35 A / 10 x I _{rat}) AC	(IEC 60127-3)					
166000	34	◆	8,4 x 7,6 mm	250 V	T	(35 A / 10 x I _{rat}) AC	IEC 60127-3/4					
166050	34	◆	8,4 x 7,6 mm	250 V	T	(35 A / 10 x I _{rat}) AC	IEC 60127-3/4					
166500	35	◆	8,4 x 7,6 mm	250 V	T	50 A AC	UL 248-14					
166550	35	◆	8,4 x 7,6 mm	250 V	T	50 A AC	UL 248-14					
166602	78	◆						8,4 x 7,6 mm	250 V AC	6,3 A	Leiterplatte	
171100	44	◆	5 x 20 mm	250 V	F	E 1000 A / D 300 A	(DIN 41571-1)					
171525	55	◆	5 x 25 mm	250 V	F	50 / 80 A AC						
171526	56	◆	5 x 25 mm	250 V	F Kennm.	G 1500 A AC	DIN 41576-1					
171530	60	◆	5 x 30 mm	500 V	F	50 / 80 A AC						
172000	45	◆	5 x 20 mm	250 V	M	C 80 A	DIN 41571-2					
172100	45	◆	5 x 20 mm	250 V	M	E 1000 A / D 300 A	DIN 41571-2					
172200	46	◆	5 x 20 mm	250 V	M	1500 A AC	(DIN 41571-2)					
172525	55	◆	5 x 25 mm	250 V	M	50 / 80 A AC						
172526	57	◆	5 x 25 mm	250 V	M Kennm.	C 80 A / E 1000 A	DIN 41576-2					
172530	60	◆	5 x 30 mm	500 V	M	50 / 80 A AC						
172900	54	◆	5 x 20 mm	250 V	M Sort.	C 80 A / E 1000 A	DIN 41571-2					
173100	51	◆	5 x 20 mm	250 V	T	D 300 A	DIN 41571-3					
179020	42	◆	5 x 20 mm	250 V	F	L (35 A / 10 x I _{rat}) AC	IEC 60127-2/2					
179021	43	◆	5 x 20 mm	250 V	F	H 1500 A AC	IEC 60127-2/1					
179120	47	◆	5 x 20 mm	250 V	T	L (35 A / 10 x I _{rat}) AC	IEC 60127-2/3					
179150	48	◆	5 x 20 mm	250 V	T	E 150 A AC	IEC 60127-2/6					
179200	49	◆	5 x 20 mm	250 V	T	H 1500 A AC	IEC 60127-2/5					
179200SMD	50	◆	5 x 20 mm	250 V	T	H 1500 A AC	IEC 60127-2/5					
179500	52	◆	5 x 20 mm	125/250 V	T	35 / 100 / 10000 A AC	UL 248-14					
179900	54	◆	5 x 20 mm	250 V	T Sort.	L (35 A / 10 x I _{rat}) AC	IEC 60127-2/3					
179901	54	◆	5 x 20 mm	250 V	F Sort.	L (35 A / 10 x I _{rat}) AC	IEC 60127-2/2					
183000	71	◆	8 x 40 mm	500 V	M-F	80 / 1500 A AC	DIN 41686					
184000	73	◆	8 x 50 mm	1,2 kV	M-F	35 A AC	DIN 41570					
185000	73	◆	8 x 85 mm	3 kV	M-F	35 A AC	DIN 41569					
186000	74	◆	8 x 120 mm	6 kV	M-F	35 A AC	DIN 41683					
187000	74	◆	8 x 150 mm	10 kV	M-F	35 A AC	DIN 41684					
189000	64	◆	6,3 x 32 mm	250 V	F	L (35 A / 10 x I _{rat}) AC	IEC 60127-2/4					
189020	65	◆	6,3 x 32 mm	440/500 V	F	50 kA AC / 20 kA DC						
189100	67	◆	6,3 x 32 mm	250 V	T	(35 A / 10 x I _{rat}) AC						
189140	68	◆	6,3 x 32 mm	440/500 V	T	10 / 1,5 A AC						
189500	69	◆	6,3 x 32 mm	125/250 V	T	35 / 100 / 10000 A AC	UL 248-14					
189700	54	◆	6,3 x 32 mm	250 V	T Sort.	(35 A / 10 x I _{rat}) AC						
189701	54	◆	6,3 x 32 mm	250 V	F Sort.	L (35 A / 10 x I _{rat}) AC	IEC 60127-2/4					
190000	53	◆	5 x 20 mm	250 V	TT	(35 A/10 x I _{rat}) AC						
199011	79	◆						5 x 20 mm	250 V AC	6,3 A	Leiterplatte	199012
199012	79	◆						5 x 20 mm	250 V AC	6,3 A	Leiterplatte	
199013	79	◆						5 x 20 mm	250 V AC	6,3 A	Leiterplatte	199023
199014	79	◆						5 x 20 mm	250 V AC	6,3 A	Leiterplatte	199023
199015	80	◆						5 x 20 mm	250 V AC	6,3 A	Leiterplatte	199016
199015A	80	◆						5 x 20 mm	250 V AC	6,3 A	Leiterplatte	199016
199016	80	◆						5 x 20 mm	250 V AC	6,3 A	Leiterplatte	(199015/A)
199018	81	◆						5 x 20 mm	250 V AC	6,3 A	Leiterplatte	199019
199018A	81	◆						5 x 20 mm	250 V AC	6,3 A	Leiterplatte	199019
199019	81	◆						5 x 20 mm	250 V AC	6,3 A	Leiterplatte	199018
199023	79	◆						5 x 20 mm	250 V AC	6,3 A	Leiterplatte	

◆ = RoHS konform ○ = nicht RoHS konform

G-Sicherungseinsätze Fuse-Links								G-Sicherungshalter Fuse-Holder				
Type	Seite Page	RoHS	Abmessungen Dimensions	Bem. spannung Rated Voltage	Charak- teristik Charac- teristic	Bem.-Ausschalt- vermögen Rated Breaking Capacity	Normen Standards	für G-Sicherg. for Fuse-Links	Bem.- spannung Rated Voltage	Bem.- strom Rated Current	Montage Mounting	Kappe Cap
199030	82	◆						5 x 20 mm	250 V AC	6,3 A	Frontplatte	Schraubk.
199035	82	◆						5 x 20 mm	250 V AC	6,3 A	Frontplatte	Schraubk.
199045	82	◆						5 x 20 mm	250 V AC	6,3 A	Leiterplatte	Renkk.
199050	83	◆						5 x 20 mm	250 V AC	6,3 A	Leiterplatte	Renkk.
199052	86	◆						6,3 x 32 mm	250 V AC	20	Frontplatte	Schraubk.
199055	83	◆						5 x 20 mm	250 V AC	6,3 A	Frontplatte	Renkk.
199060	80	◆						5 x 20 mm	250 V AC	6,3 A	Leiterplatte	
199070	83	◆						5 x 20 mm	250 V AC	10 A	Frontplatte	Renkk.
199073	78	◆						5 mm Ø	500 V AC	6,3 A	Leiterplatte	
199080	84	◆						5 x 20 mm	42 V AC	6,3 A	In-line	Renkk.
199080A	84	◆						5 x 20 mm	42 V AC	6,3 A	In-line	Renkk.
199090	84	◆						5 x 20 mm	250 V AC	6,3 A+10 A	Frontplatte	Renkk.
199207	78	◆						5 mm Ø	500 V AC	6,3 A	Leiterplatte	
199429	78	◆						6,3 mm Ø	500 V AC	6,3 A	Leiterplatte	
199487	78	◆						5 mm Ø	500 V AC	6,3 A	Leiterplatte	
199511	85	◆						5 x 20 mm	500 V AC	16 A	Leiterplatte	
199511	85	◆						6,3 x 32 mm	500 V AC	16 A	Leiterplatte	
199530	85	◆						6,3 x 32 mm	500 V AC	20 A	Frontplatte	
199531	85	◆						6,3 x 32 mm	500 V AC	20 A	Frontplatte	Renkk.
199537	86	◆						5 x 20 mm	500 V AC	16 A	Leiterplatte	
199537	86	◆						6,3 x 32 mm	500 V AC	16 A	Leiterplatte	
199550	86	◆						6,3 x 32 mm	500 V AC	30 A	Leiterplatte	
199552	86	◆						6,3 x 32 mm	500 V AC	30 A	Leiterplatte	Schraubk.
199555	87	◆						6,3 x 32 mm	500 V AC	30 A	Frontplatte	
199552	87	◆						6,3 x 32 mm	500 V AC	30 A	Frontplatte	Schraubk.
204000	89	◆						5 mm Ø		6,3 A	Leiterplatte	
204001	89	◆						5 mm Ø		10 A	Leiterplatte	
204002	89	◆						5 mm Ø		16 A	Leiterplatte	
204100	90	◆						6,3 mm Ø		12,5 A	Leiterplatte	
204101	90	◆						6,3 mm Ø		20 A	Leiterplatte	
204151	90	◆						6,3 mm Ø		20 A	Leiterplatte	
7000140	38	◆	5 x 20 mm	250 V	FF	300 / 1,5 kA AC						
7000740	39	◆	5 x 20 mm	250/400 V	FF	300 / 10 kA AC						
7001205	59	◆	5 x 20 mm	250 V	M Kennm.	G 1500 A	DIN 41577 T.2					
7001407	59	◆	5 x 20 mm	250 V	M Kennm.	G 1500 A	DIN 41577 T.2					
7001607	59	◆	5 x 25 mm	250 V	M Kennm.	C 80 A	DIN 41577 T.2					
7001707	59	◆	5 x 25 mm	250 V	M Kennm.	G 1500 A	DIN 41577 T.2					
7006526	70	◆	6,3 x 32 mm	400 V	gPV	30 kA DC						
7006584	63	◆	6,3 x 32 mm	400 V	gRL	120 kA AC	IEC 60269-4					
7008913	58	◆	5 x 25 mm	450 V	F	70 kA AC						
7009463	66	◆	6,3 x 32 mm	600 V	F	50 kA AC						
7012540	61	◆	6,3 x 32 mm	500/700 V	FF	50 kA AC						
7017240	62	◆	6,3 x 32 mm	1000 V	aR (FF)	30 kA AC / DC						
7017640	41	◆	5 x 20 mm	1000 V	aR (FF)	100 kA AC / DC						
7018040	40	◆	5 x 20 mm	660 V	aR (FF)	100 kA AC / DC						
7018509	72	◆	8 x 65 mm	1500 V	F	30 kA AC / DC						
7100114	92	◆						5 x 20 mm	250 V AC	16 A	Leiterplatte	Renkk.
7100114	92	◆						6,3 x 32 mm	250 V AC	16 A	Leiterplatte	Renkk.
7100116	92	◆						5 x 20 mm	250 V AC	16 A	Leiterplatte	Renkk.
7100116	92	◆						6,3 x 32 mm	250 V AC	16 A	Leiterplatte	Renkk.
7100123	91	◆						5 x 20 mm	250 V AC	20 A	Frontplatte	Renkk.
7100123	91	◆						6,3 x 32 mm	250 V AC	20 A	Frontplatte	Renkk.
7100124	91	◆						5 x 20 mm	250 V AC	20 A	Frontplatte	Renkk.
7100124	91	◆						6,3 x 32 mm	250 V AC	20 A	Frontplatte	Renkk.
7100127	88	◆						5 x 20 mm	250 V AC	16 A	Leiterplatte	Renkk.
7100128	88	◆						5 x 20 mm	250 V AC	16 A	Leiterplatte	Renkk.
7100129	89	◆						5 x 20 mm	250 V AC	10 A	Frontplatte	Renkk.
7102901	94	◆						12 x 100 mm	3 kV			
7103001	94	◆						12 x 150 mm	6 kV			
7103101	94	◆						12 x 200 mm	10 kV			
7103401	93	◆						8 x 50 mm	1,2 kV AC		Isolierplatte	
7103701	93	◆						8 x 85 mm	3 kV AC		Isolierplatte	
7103701	93	◆						10 x 85 mm	3 kV	6,3 A		
7103702	94	◆						10 x 85 mm	3 kV	6,3 A		
7104001	93	◆						8 x 120 mm	6 kV AC		Isolierplatte	
7104301	93	◆						8 x 150 mm	10 kV AC		Isolierplatte	
7200108	92	◆						5 x 20 mm	250 V AC	20 A	Frontplatte	Renkk.
7200109	92	◆						6,3 x 32 mm	250 V AC	20 A	Frontplatte	Renkk.
7500101	54	◆	5 x 20 mm	250 V	F + T Sort.							

Technische Erläuterungen / Technical Notes

1 Einleitung

Geräteschutzsicherungen (G-Sicherungen) sind selbsttätig arbeitende Schaltorgane und schützen elektrische Anlagen, Geräte und Baugruppen vor unzulässig hohen Strombelastungen. Die Anwendung ist vielfältig. Geräteschutzsicherungen werden in der Unterhaltungselektronik zur Absicherung von Netzteilen und Leistungsendstufen verwendet. Für industrielle Anwendungen werden G-Sicherungen häufig als Primärsicherung eingesetzt, wo sie im Fehlerfall die defekte Baugruppe von der Spannungsversorgung trennen, bevor es zu größeren Schäden kommt. Sicherungseinsätze für die direkte Leiterplattenmontage werden unter anderem für die sekundäre Stromversorgung in Geräten kleiner Leistung verwendet. Im Fehlerfall dienen sie zum Schutz von Bauteilen und Leiterbahnen, die durch zu hohe Strombelastungen zerstört werden könnten.

2 Ausführungen

Die klassische Geräteschutzsicherung hat eine zylindrische Bauform im Durchmesser 5 mm und eine Länge von 20 mm. Daneben findet eine Ausführung in den Abmessungen 6,3 x 32 mm weltweite Anwendung. In den Charakteristiken superflink bis superträge und bei Netzspannungen bis 1000 V können diese Sicherungen je nach Bemessung Kurzschlussströme bis zu einigen Kiloampère ausschalten.

Zur bedrahteten Montage auf Leiterplatten werden Kleinstsicherungen (KS) verwendet. Diese Sicherungen in der Bemessungsspannung 250 V sind in flinker und träger Charakteristik sowohl primärseitig zum Schutz eines Netztransformators als auch sekundärseitig zum selektiven Schutz der Baugruppen im Einsatz.

Zur Oberflächenmontage auf Leiterplatten stehen SMD-Sicherungen in Bemessungsspannungen bis 250 V zur Verfügung. Die Sicherungen werden ähnlich wie die oben beschriebenen KS-Sicherungen verwendet. Sie sind bezüglich ihres Ausschaltverhaltens auch auf die besonderen Anforderungen der Telecom-Industrie ausgerichtet.

1 Introduction

Miniature fuses are automatic switchgears that protect electrical plants, appliances and modules from inadmissibly high current loads.

They have various applications. Miniature fuses are used in consumer electronics for safeguarding power supplies and power output amplifiers. They are often used in industrial applications as primary fuses, where in the event of a fault they separate the defective module from the voltage supply in order to forestall any greater damage. Fuse-links for direct mounting on printed circuit boards are used among other things for the secondary current supply in low power devices. In the event of a fault they serve to protect components and PCB-traces that might be destroyed by excessive current loads.

2 Designs

The traditional miniature fuse is cylindrical in shape, with a diameter of 5 mm and a length of 20 mm. There is also a design used internationally which has the dimensions 6.3 x 32 mm. Depending on their rating, these fuses, whose characteristic might be very quick-acting to long time-lag, can switch off short-circuit currents of up to several kiloamperes at mains voltages of up to 1 000 V.

Sub-miniature fuses (KS) are used for through-hole assembly on printed circuit boards. Whether their characteristic is quick-acting or time-lag, these fuses with a rated voltage of 250 V are used in primary circuits for protecting mains transformers and in secondary circuits for selective protection of the modules.

SMD fuses at rated voltages of up to 250 V are available for surface mounting on printed circuit boards. Their applications are similar to those of the sub-miniature fuses (KS) described above. As regards their breaking performance, they are also designed with the special requirements of the telecom industry in mind.

3 Begriffe

G-Sicherungen bestehen aus dem Sicherungseinsatz und dem Sicherungshalter. Der Sicherungseinsatz enthält den Schmelzleiter und muss nach dessen Schmelzen durch einen neuen Sicherungseinsatz ersetzt werden. Der Schmelzleiter kann unter vorgegebenen Bedingungen den Bemessungsstrom dauerhaft führen. Bei Überschreitung des Bemessungsstroms, oberhalb eines durch die Normen vorgegebenen Wertes schmilzt er, und es kommt zu einer Unterbrechung des Stromkreises. Die Dauer des Schmelzvorgangs ist in den entsprechenden Normen vorgegeben. Der Sicherungseinsatz wird in einen Sicherungshalter eingesetzt. Dieser besteht aus dem Sicherungsunterteil (Sockel) und dem Sicherungseinsatzträger (Schraub- oder Renkkappe). Das Sicherungsunterteil ist fest im zu schützenden Gerät montiert und stellt die elektrische Verbindung her. Der Sicherungseinsatzträger nimmt den Sicherungseinsatz auf und ermöglicht ein einfaches Austauschen. Neben solchen ‚geschlossenen‘ Sicherungshaltern werden häufig auch offene Sicherungshalter und Clips verwendet. Für die richtige Auswahl eines Sicherungseinsatzes sind die elektrischen Eigenschaften, wie im Folgenden erläutert, zu berücksichtigen.

3.1 Bemessungsspannung (Nennspannung) U_{rat}

Die Bemessungsspannung eines Sicherungseinsatzes wird als Effektivwert einer sinusförmigen Wechselspannung bei 50 Hz angegeben. Nach ihr sind alle Prüfbedingungen festgelegt. Die den Kurzschlussstrom treibende Spannung U_b darf nicht größer sein als die Bemessungsspannung.

$$U_{\text{rat}} \geq U_b$$

Der Einsatz bei Gleichspannung ist unter Reduzierung der Bemessungsspannung möglich; bei Angabe des maximalen Fehlerstroms und der Zeitkonstanten des Fehlerstromkreises geben wir hierzu gern Auskunft.

3.2 Bemessungsstrom I_n

Der Bemessungsstrom wird als Effektivwert angegeben. Der Sicherungseinsatz kann unter vorgegebenen Bedingungen mit dem Bemessungsstrom dauerhaft betrieben werden. Umgebungsbedingungen, zyklische Ströme und besondere Einbauverhältnisse können zu einer Herabstufung (derating) des Bemessungsstromes führen. Der Betriebsstrom I_b darf im Normalbetrieb nicht größer sein als der Bemessungsstrom.

$$I_n \geq I_b$$

3 Terminology

Miniature fuses consist of the fuse-link and the fuse-holder. The fuse-link contains the fuse-element and must, after the latter has melted, be replaced by a new fuse-link. The fuse-element can continuously carry the rated current under given conditions. When the rated current has been exceeded, the fuse-element melts above a value prescribed by the standards, and the electrical circuit is broken. The duration of the melting process is prescribed in the relevant standards.

The fuse-link is inserted into a fuse-holder. The latter consists of the fuse-base (mount) and the (screw or bayonet) fuse-carrier. The fuse-base is firmly mounted in the device to be protected and provides the electrical connection. The fuse-carrier receives the fuse-link, allowing easy replacement. Open fuse-holders and clips are often used besides such 'enclosed' fuse-holders.

The electrical characteristics must be taken into account when making the correct choice of a fuse-link, as explained in the following.

3.1 Rated voltage (nominal voltage) U_{rat}

The rated voltage of a fuse-link is given as the r.m.s. value of a sinusoidal alternating voltage at 50 Hz. All the test conditions are laid down in accordance with it. The voltage U_b driving the short-circuit current must not be greater than the rated voltage.

$$U_{\text{rat}} \geq U_b$$

Operation at direct voltage is possible if the rated voltage is reduced; we will be glad to advise you on this matter if you provide us with the maximum fault current and the time constants of the fault-current circuit.

3.2 Rated Current I_n

The rated current given is the r.m.s. value. Under prescribed conditions, the fuse-link can operate permanently at the rated current level. Ambient conditions, cyclic currents and special assembly conditions can lead to a derating of the rated current. The operating current I_b must not be greater than the rated current during normal operation.

$$I_n \geq I_b$$

3.3 Bemessungsausschaltvermögen I_1 bei U_{rat}

Das Bemessungsausschaltvermögen kennzeichnet den maximalen Strom I_1 , den der Sicherungseinsatz bei Bemessungsspannung ordnungsgemäß abschalten kann. In manchen Anwendungsfällen kann es erforderlich sein, den zu erwartenden Kurzschlussstrom durch zusätzliche Impedanzen im Stromkreis zu verringern.

$$I_1 \geq I_p$$

3.4 Spannungsfall ΔU

Der Spannungsfall wird bei Betrieb des Sicherungseinsatzes mit seinem Bemessungsstrom und bei einer Umgebungstemperatur von 23 °C ermittelt.

3.5 Schmelzintegral I^2t_g

Das Schmelzintegral errechnet sich aus der Integration des Stromquadrats über der Schmelzzeit. Der Wert gibt an, welche elektrische Belastung zum Auftrennen des Schmelzleiters führt. Der Schmelzintegralwert wird bei einem Prüfstrom von $10 I_{rat}$ ermittelt und als typischer Wert angegeben.

3.6 Ausschaltintegral I^2t_A

Das Ausschaltintegral errechnet sich aus der Integration des Stromquadrats über der gesamten Ausschaltzeit des Sicherungseinsatzes. Der Wert ist ein Maß für die Belastung der nachgeschalteten Bauelemente während einer Ausschaltung des Sicherungseinsatzes im Kurzschlussfall.

3.7 Leistungsabgabe P_v

Die Leistungsabgabe eines Sicherungseinsatzes errechnet sich aus der Multiplikation des kleinen Prüfstroms I_{nf} mit dem bei dieser Belastung nach 1 h ermittelten Spannungsfall ΔU .

4 Der Aufbau von G-Sicherungseinsätzen

4.1 Das Glasrohr

Ist der maximal zu erwartende Kurzschlussstrom (prospektiver Strom I_p) nicht größer als 35 A oder max. $10 I_{rat}$, so wird ein G-Sicherungseinsatz mit Glasrohr ohne Füllung verwendet. Dieser Sicherungseinsatz hat den Vorteil eines relativ niedrigen Spannungsfalls.

4.2 Das verstärkte Glasrohr

G-Sicherungseinsätze mit verstärktem Glasrohr ohne Füllung können prospektive Ströme bis 150 A bei Bemessungsspannung ausschalten.

3.3 Rated Breaking Capacity $I1$ at U_{rat}

The rated breaking capacity characterises the maximum current I_1 that the fuse-link can properly switch off at the rated voltage.

In certain applications it may be necessary to reduce the expected short-circuit current by means of additional impedances in the electrical circuit.

$$I_1 \geq I_p$$

3.4 Voltage Drop ΔU

The voltage drop is determined with the fuse-link in operation at its rated current and at an ambient temperature of 23 °C.

3.5 Pre-arcing integral I^2t_g

The pre-arcing integral is calculated by integrating the square of the current over the pre-arcing time. The value indicates the electrical load that leads to the melting of the fuse-element. The value for the pre-arcing integral is determined at a test current of $10 I_{rat}$ and is given as a typical value.

3.6 Operating integral I^2t_A

The operating integral is calculated by integrating the square of the current over the total operating time of the fuse-link. The value is a measure of the load on the downstream components during breaking operation of the fuse-link in the event of a short circuit.

3.7 Power dissipation P_v

The Power dissipation of a fuse-link is calculated by multiplying the conventional non-fusing current I_{nf} by the voltage drop ΔU determined at this load after an hour.

4 Structure of miniature Fuse-Links

4.1 The glass tube

If the maximum expected short-circuit current (prospective current I_p) is not greater than 35 A or max. $10 I_{rat}$, then a miniature fuse-link with an unfilled glass tube is used. This fuse-link has the advantage of a relatively low voltage drop.

4.2 The reinforced glass tube

Miniature fuse-links with reinforced unfilled glass tubes can switch off prospective currents of up to 150 A at the rated voltage.

4.3 Das Glasrohr mit Füllung

Durch die Kombination einer Quarzsandfüllung als Löschmittel und die Verstärkung des Glasrohrs können prospektive Ströme bis zu 1000 A bei Bemessungsspannung ausgeschaltet werden.

4.4 Das Keramikrohr mit Füllung

Eine weitere Steigerung des Bemessungsausschaltvermögens bis zu einem prospektiven Strom von einigen kA wird durch die Verwendung von Keramikrohren mit Quarzsandfüllung erzielt.

4.5 Die Anschlusskappen

Als Werkstoff für Anschlusskappen wird üblicherweise eine Kupferlegierung verwendet. Zur besseren elektrischen und thermischen Kontaktgabe sowie zum Korrosionsschutz werden die Kappen durch eine besondere Oberflächenbehandlung vergütet.

4.3 The filled glass tube

Prospective currents of up to 1 000 A can be switched off at the rated voltage by a combination of quartz sand filling as extinguishing filler and reinforcement of the glass tube.

4.4 The filled ceramic tube

A further increase in the rated breaking capacity up to a prospective current of several kA is achieved by the use of ceramic tubes filled with quartz sand.

4.5 The terminal caps

A copper alloy is usually used as working material for the terminal caps. The caps are plated by means of a special surface treatment to provide better electrical and thermal contact, as well as for protection against corrosion.

5 Charakteristiken

Die Charakteristik ist ein Ausdruck für das Zeit/Strom-Verhalten der Sicherungseinsätze.

FF	superflink	Kurzschlusschutz für Halbleiterbauelemente (Thyristoren, Dioden, Triacs, Transistoren, MCT usw.)
gRL	superflink	Ganzbereichsschutz von Halbleitern und deren Zuleitungen
gPV		für Energiesysteme der Photovoltaik
F	flink	Schutz gegen hohe Überlast- und Kurzschlussströme; Sicherungen werden in Stromkreisen ohne Einschaltstromstöße oder als Netzsicherung eingesetzt.
M	mittelträge	durch niedrigen Spannungsfall besonders geeignet zum Einsatz bei kleinen Betriebsspannungen, wenn keine großen Einschaltströme zu berücksichtigen sind.
T	träge	bei hohen und nur langsam abklingenden Einschaltströmen (Transformatoren)
TT	superträge	bei sehr hohen und länger andauernden Einschaltströmen (Motoren)

6 Normen

Neben einer Vielzahl spezieller nationaler Standards kommt weltweit in erster Linie IEC 60127 zur Anwendung. Sie gliedert sich in einen allgemeinen Teil, in Teile, die die einzelnen Sicherungsausführungen beinhalten, einem Teil für Sicherungshalter, eine Festlegung zur Gütebestätigung sowie einen Anwendungsleitfaden. Das deutschsprachige Äquivalent dieser internationalen Norm ist VDE 0820.

5 Characteristics

The characteristic is an expression for the time/current performance of the fuse-links.

FF	very quick-acting	short-circuit protection for semiconductor components (thyristors, diodes, triacs, transistors, MCT etc.)
gRL	very quick-acting	full-range protection of semiconductors and their supply lines
gPV		for energy systems of photovoltaic
F	quick-acting	protection against high overload and short-circuit currents; fuses are used in electrical circuits without inrush current pulses, or as mains fuses.
M	medium time-lag	because of low voltage drop particularly suitable at low operating voltages, if no high inrush currents have to be taken into account.
T	time-lag	for high inrush currents that only decay slowly (transformers)
TT	long time-lag	for very high and long-lasting inrush currents (motors).

6 Standards

Besides several specific national standards, the principal standard applied worldwide is IEC 60127. It is divided into one general part, parts dealing with the individual fuse designs, one part for fuse-holders, one specification for quality confirmation as well as one user's manual. The German-language equivalent of this International Standard is VDE 0820.

In den nordamerikanischen Ländern ist die Bezugsnorm für Geräteschutzsicherungen UL 248. Besondere Vorsicht ist geboten bei der Konvertierung der Bemessungsströme von IEC 60127 zu denen nach UL 248 (siehe Bild 1).

In the North American countries, the reference standard for miniature fuses is UL 248. Special care is required in converting the rated currents of IEC 60127 into those according to UL 248 (see figure 1).

7 Applikationen

7.1 Unterschiedliche Definition der Bemessungsströme in den internationalen Normen

Grundsätzlich müssen zwei unterschiedliche Bemessungen des Dauerstroms berücksichtigt werden, die eine direkte Konvertierung der Sicherungseinsätze nach IEC 60127 und UL 248-14 nicht zulassen.

a) Dauerstrombemessung nach IEC 60127

$$I_n \geq I_b$$

b) Dauerstrombemessung nach UL 248-14

$$I_n \geq I_b / 0,7$$

7 Applications

7.1 Different definitions of the Rated Currents in the International Standards

In principle, two different ratings of the continuous current must be taken into account, preventing direct conversion of the fuse-links according to IEC 60127 and UL 248-14.

a) Continuous current rating according to IEC 60127

$$I_n \geq I_b$$

b) Continuous current rating according to UL 248-14

$$I_n \geq I_b / 0,7$$

Bild 1 ermöglicht die jeweilige Übertragung der Bemessungsströme zwischen den beiden Normen.



Bild / Figure 1

Figure 1 enables appropriate conversion of the rated currents between the two standards.

7.2 Betrieb bei Kleinspannung $U_b \ll U_{rat}$

Sicherungseinsätze können ohne weiteres mit Spannungen unterhalb ihrer Bemessungsspannung betrieben werden. Besonders bei sehr niedrigen Bemessungsströmen, muss der Spannungsfall der Sicherungseinsätze (Innenwiderstand) berücksichtigt werden.

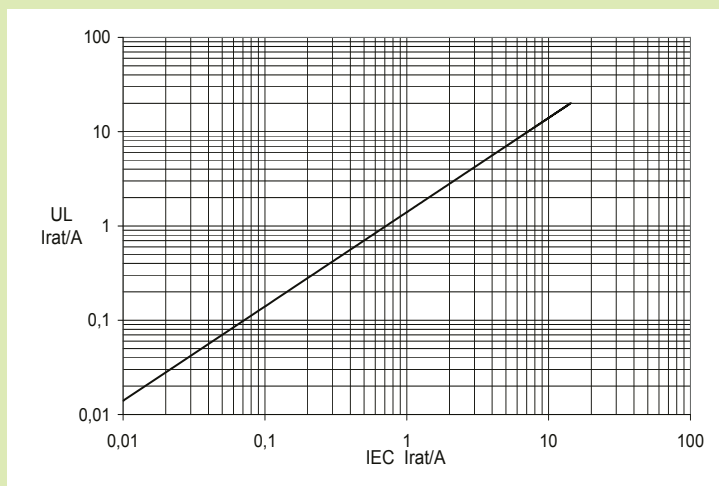
7.2 Operation at extra-Low-Voltage $U_b \ll U_{rat}$

Fuse-links can operate without difficulty at voltages below their rated voltage. The voltage drop of the fuse-links (internal resistance) must be taken into consideration, particularly at very low rated currents.

7.3 Betrieb bei erhöhten Umgebungstemperaturen

Sicherungseinsätze sind entsprechend den Normvorgaben für eine Temperatur von 23 °C ausgelegt. Der Einbau in einem geschlossenen Sicherungshalter sowie benachbarte Wärmequellen können den Bemessungsstrom des Sicherungseinsatzes verändern.

7.3 Operation at raised ambient temperatures

Fuse-links are designed for a temperature of 23 °C, as prescribed in the standards. Installation in an enclosed fuse-holder or neighbouring heat sources can change the rated current of the fuse-link.

Anhand Bild 2 kann die Verschiebung des Bemessungsstroms bei unterschiedlichen Umgebungstemperaturen ermittelt werden.

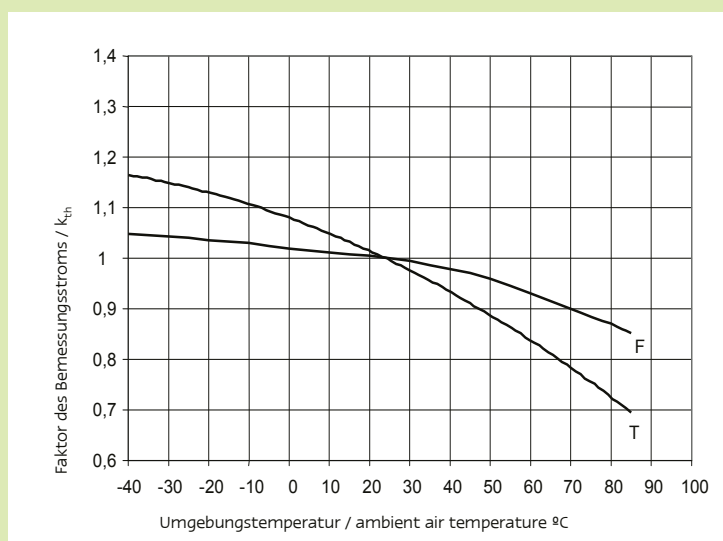

The shift in the rated current at various ambient temperatures can be determined with reference to Figure 2.

Bild / Figure 2

7.4 Pulsbelastungen

Treten in einem zu schützenden Stromkreis Pulsbelastungen auf, muss dies bei der Zuordnung des Sicherungseinsatzes, insbesondere seines Schmelzintegrals I^2t_{sa} , berücksichtigt werden. Auf Basis umfangreicher eigener Testreihen in Bezug auf Pulshöhe, Pulsdauer und Häufigkeit können Reduktionsfaktoren zur Verfügung gestellt werden.

7.4 Pulse loads

If pulse loads arise in an electrical circuit to be protected, then that must be taken into consideration when assigning a fuse-link, particularly the latter's pre-arcing integral I^2t_s . Reduction factors can be provided on the basis of extensive series of in-house tests relating to pulse amplitude, pulse duration and frequency of occurrence.

7.5 Schutz von Halbleiterbauelementen

Beim Schutz von Bauelementen der Leistungselektronik wird der I^2t -Wert des Sicherungseinsatzes auf das Grenzlast-Integral des zu schützenden Bauteils abgestimmt.

7.5 Protection of semiconductor components

When protecting power electronics components, the I^2t value of the fuse-link is adjusted to the energy pulse (or I^2t value) of the component to be protected.

7.6 Leistungsaufnahme des G-Sicherungshalters

Die maximale Leistungsaufnahme des Sicherungshalters darf von der Leistungsabgabe des ausgewählten Sicherungseinsatzes nicht überschritten werden. Die Kontaktwiderstände und die Einbauverhältnisse sind hierbei zusätzlich zu berücksichtigen.

7.6 Power acceptance of the miniature Fuse-Holder

The maximum power acceptance of the fuse-holder must not be exceeded by the Power dissipation of the fuse-link selected. Contact resistances and assembly conditions shall additionally be taken into account here.

8 Sicherheit durch Qualität

Zur Sicherstellung der Qualitätsforderungen praktiziert SIBA das dokumentierte Qualitätsmanagement-System (QM-System) auf der Grundlage der internationalen Norm DIN EN ISO 9001. Das Umwelt-Management-System nach DIN EN ISO 14001 regelt die Planung, Umsetzung und Kontrolle des Umweltschutzes im Unternehmen.

9 Auswahldiagramm

siehe nächste Seite

8 Safety through Quality

In order to ensure compliance with the quality requirements, SIBA practices the documented quality management system (QM system) on the basis of the International Standard DIN EN ISO 9001. The environmental management system according to DIN EN ISO 14001 regulates the planning, implementation and supervision of environmental protection in the company.

9 Selection diagram

see next page

Auswahldiagramm / Selection diagram

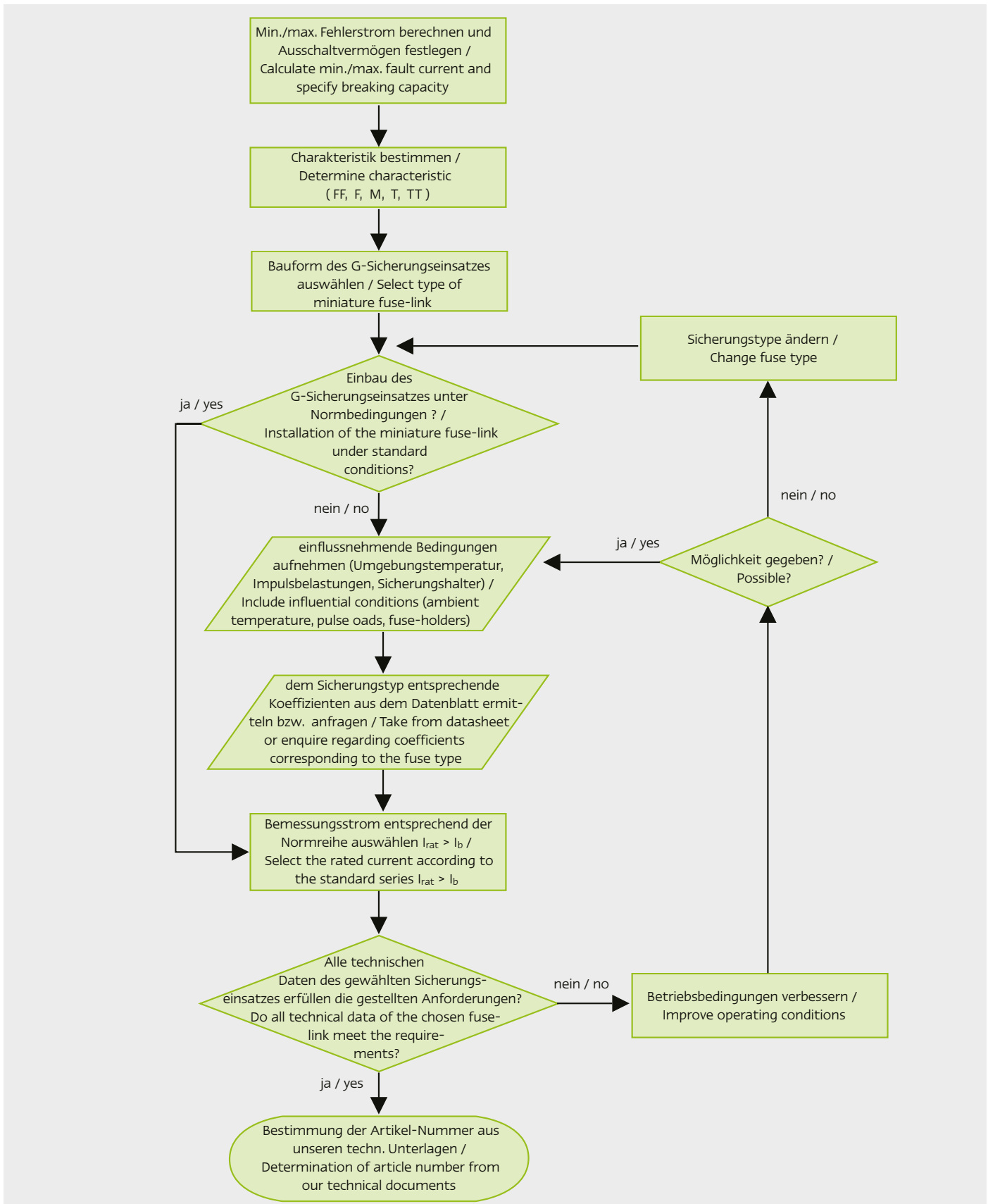

Kleinstsicherungen / Sub-miniature Fuses

Chip-Sicherungen / Chip Fuses
SMD-Sicherungen / SMD Fuses
Kleinstsicherungen / Sub-miniature Fuses

Type
151000

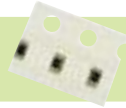

Zeit/Strom-Kennlinien
Time-Current Characteristics

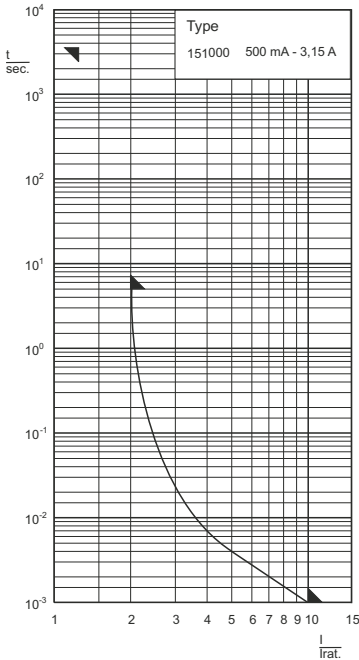

Abmessungen
Dimensions

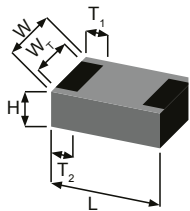

H	0,32 ±0,05 mm
L	1,0 ±0,05 mm
W	0,5 ±0,05 mm
W _T	> 75% von/of W
T ₁	0,2 +0,1 / -0,15 mm
T ₂	0,2 ±0,1 mm

Empfohlene Anschlussflächen
Recommended pad layout

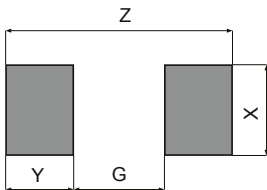

	Reflow	Reflow
G	0,25 mm	
X	0,55 mm	
Y	0,6 mm	
Z	1,45 mm	

Aufbau / Construction

Keramiksubstrat / ceramic substrate
Schmelzleiter gedruckt / printed fuse-element

Lötwärmebeständigkeit /
resistance to soldering heat: 260 °C, 10 s (Lötbad / solder bath)
(nach IEC 60068-2-58 / to IEC 60068-2-58) 260 °C, 10 s (reflow)

Vibration / vibration: IEC 60068-2-6
Isolationswiderstand / insulation resistance IEC 60127-4

Schmelzeitgrenzwerte / Fusing time limits

Bemessungsstrom Rated Current	1,25 I _n	2 I _n	2,75 I _n		4 I _n		10 I _n	
	min.	max.	min.	max.	min.	max.	min.	max.
500 mA - 3,15 A	1 h	1 s	-	-	-	-	-	1 ms

UL 248-14	0402 1 x 0,5 mm	32 V	FF superflink very quick acting
-----------	---------------------------	------	---------------------------------------

Artikel-Nr. Article-no.	Bemessungsstrom Rated Current	Bemessungs-Ausschaltvermögen Rated Breaking Capacity	Spannungsfall Voltage Drop	Kaltwiderstand Cold Resistance	Schmelzintegral I ² t _s Value	Kennzeichnung Marking	Approbationen Approvals
			mV	mΩ	A ² s		UL rec.
151000.0,5	500 mA	50 A @ DC 32 V	420	640	0,0009		✓
151000.0,63	630 mA	50 A @ DC 32 V	331	400	0,0014		✓
151000.0,75	750 mA	50 A @ DC 32 V	275	280	0,002		✓
151000.0,8	800 mA	50 A @ DC 32 V	231	220	0,0023		✓
151000.1	1 A	50 A @ DC 32 V	184	140	0,0028		✓
151000.1,25	1,25 A	50 A @ DC 32 V	159	97	0,0039		✓
151000.1,5	1,5 A	50 A @ DC 32 V	146	74	0,0059		✓
151000.1,6	1,6 A	50 A @ DC 32 V	136	65	0,0065		✓
151000.1,75	1,75 A	50 A @ DC 32 V	124	54	0,0077		✓
151000.2	2 A	50 A @ DC 32 V	115	44	0,0101		✓
151000.2,5	2,5 A	50 A @ DC 32 V	107	33	0,0157		
151000.3	3 A	50 A @ DC 32 V	95	24	0,0227		
151000.3,15	3,15 A	50 A @ DC 32 V	90	22	0,025		

Type	Abk. Abbr.	Beschreibung Description
151000	GT-1K	1.000 Stück gegurtet / 1.000 pieces on tape
	GT-5K	5.000 Stück gegurtet / 5.000 pieces on tape
	GT-10K	10.000 Stück gegurtet / 10.000 pieces on tape
z.B./ e.g.		151000.0,75GT-1K

Type 152000



Zeit/Strom-Kennlinien
Time-Current Characteristics

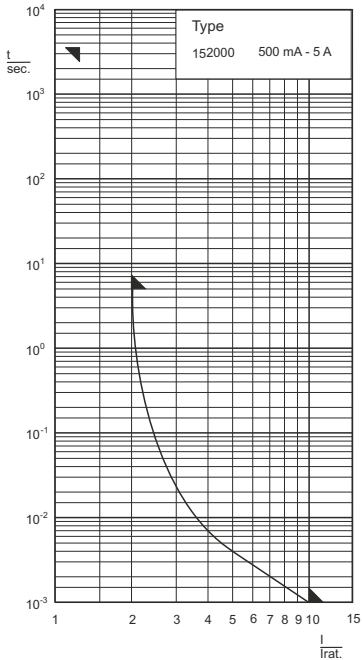

Abmessungen
Dimensions

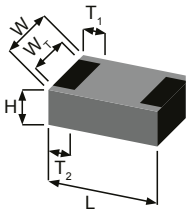

H	0,45 +0,1 / -0,05 mm
L	1,55 ±0,05 mm
W	0,85 ±0,1 mm
W _T	> 75% von/of W
T ₁	0,3 +0,15 / -0,2 mm
T ₂	0,3 +0,15 / -0,2 mm

Empfohlene Anschlussflächen
Recommended pad layout

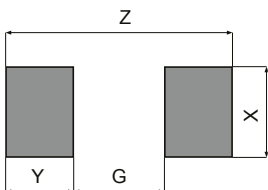

Lötung Soldering	Reflow Reflow	Welle Wave
G	0,5 mm	0,5 mm
X	0,95 mm	1,1 mm
Y	0,95 mm	1,2 mm
Z	2,4 mm	2,9 mm

Aufbau / Construction

Keramiksubstrat / ceramic substrate
Schmelzleiter gedruckt / printed fuse-element

Lötwärmebeständigkeit /
resistance to soldering heat: 260 °C, 10 s (Lötbad / solder bath)
(nach IEC 60068-2-58 / to IEC 60068-2-58) 260 °C, 10 s (reflow)

Vibration / vibration: IEC 60068-2-6
Isolationswiderstand / insulation resistance IEC 60127-4

Schmelzeitgrenzwerte / Fusing time limits

Bemessungsstrom Rated Current	1,25 I _n		2 I _n		2,75 I _n		4 I _n		10 I _n	
	min.	max.	min.	max.	min.	max.	min.	max.	min.	max.
500 mA - 5 A	1 h	5 s	-	-	-	-	-	-	-	1 ms

UL 248-14 IEC 60127-4	0603 1,55 x 0,85 mm	32 V	FF superflink very quick acting
--------------------------	-------------------------------	------	---------------------------------------

Artikel-Nr. Article-no.	Bemessungs- strom Rated Current	Bemessungs- Ausschaltvermögen Rated Breaking Capacity	Spannungsfall Voltage Drop	Kalt- widerstand Cold Resistance	Schmelz- integral I ² t ₉₀ Value	Kenn- zeichnung Marking	Approbationen Approvals
			mV	mΩ	A ² s		UL rec. VDE
152000.0,5	500 mA	50 A @ DC 32 V ¹⁾	361	550	0,0009	F	✓ ✓
152000.0,63	630 mA	50 A @ DC 32 V	331	400	0,0014	CT	✓
152000.0,75	750 mA	50 A @ DC 32 V	258	262	0,002	G	✓
152000.0,8	800 mA	50 A @ DC 32 V	249	237	0,0023	CV	✓
152000.1	1 A	50 A @ DC 32 V ¹⁾	223	170	0,0028	H	✓ ✓
152000.1,25	1,25 A	50 A @ DC 32 V	180	110	0,0039	J	✓
152000.1,5	1,5 A	50 A @ DC 32 V	155	79	0,0059	K	✓
152000.1,6	1,6 A	50 A @ DC 32 V ¹⁾	159	76	0,0065	EF	✓ ✓
152000.1,75	1,75 A	50 A @ DC 32 V	138	60	0,0077	L	✓
152000.2	2 A	50 A @ DC 32 V ¹⁾	150	57	0,0101	N	✓ ✓
152000.2,5	2,5 A	50 A @ DC 32 V	151	37	0,0157	O	✓
152000.3	3 A	50 A @ DC 32 V	126	32	0,0227	P	✓
152000.3,15	3,15 A	50 A @ DC 32 V ¹⁾	120	29	0,025	EL	✓ ✓
152000.3,5	3,5 A	50 A @ DC 32 V	106	23	0,0308	R	✓
152000.4	4 A	50 A @ DC 32 V	100	19	0,0403	S	✓
152000.5	5 A	50 A @ DC 32 V	85	13	0,2275	T	

¹⁾ 50 A @ DC 50 V mit/with VDE Approbation/approval

Type	Abk. Abbr.	Beschreibung Description
152000	GT-1K	1.000 Stück gegurtet / 1.000 pieces on tape
	GT-5K	5.000 Stück gegurtet / 5.000 pieces on tape
	GT-20K	20.000 Stück gegurtet / 20.000 pieces on tape
z.B./ e.g.	152000.3,15GT-1K	

Type
153000



Zeit/Strom-Kennlinien
Time-Current Characteristics

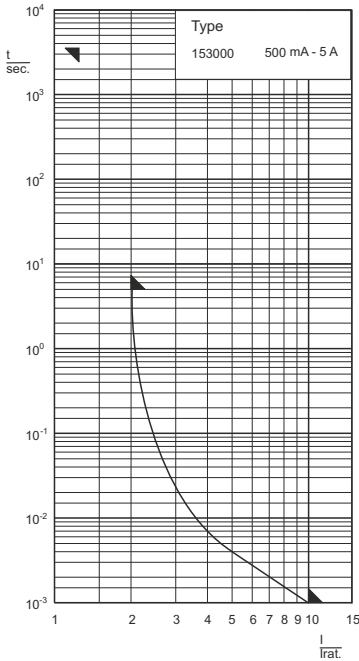

Abmessungen
Dimensions

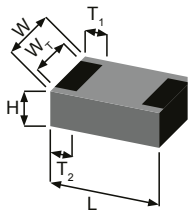

H	0,45 +0,1 / -0,05 mm
L	2,0 ±0,1 mm
W	1,25 ±0,15 mm
W _T	> 75% von/of W
T1	0,4 +0,1 / -0,2 mm
T2	0,4 +0,1 / -0,2 mm

Empfohlene Anschlussflächen
Recommended pad layout

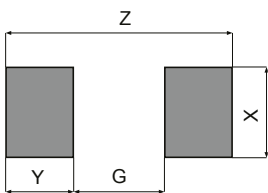

Lötung Soldering	Reflow Reflow	Welle Wave
G	0,65 mm	0,65 mm
X	1,4 mm	1,5 mm
Y	1,1 mm	1,4 mm
Z	2,85 mm	3,45 mm

Aufbau / Construction

Keramiksubstrat / ceramic substrate
Schmelzleiter gedruckt / printed fuse-element

Lötwärmebeständigkeit /
resistance to soldering heat: 260 °C, 10 s (Lötbad / solder bath)
(nach IEC 60068-2-58 / to IEC 60068-2-58) 260 °C, 10 s (reflow)

Vibration / vibration: IEC 60068-2-6
Isolationswiderstand / insulation resistance IEC 60127-4

Schmelzeitgrenzwerte / Fusing time limits

Bemessungsstrom Rated Current	1,25 I _n		2 I _n		2,75 I _n		4 I _n		10 I _n	
	min.	max.	min.	max.	min.	max.	min.	max.	min.	max.
500 mA - 5 A	1 h	5 s	-	-	-	-	-	-	-	1 ms

UL 248-14 IEC 60127-4	0805 2 x 1,25 mm	32 V	FF superflink very quick acting
--------------------------	----------------------------	------	---------------------------------------

Artikel-Nr. Article-no.	Bemessungs- strom Rated Current	Bemessungs- Ausschaltvermögen Rated Breaking Capacity	Spannungsfall Voltage Drop	Kalt- widerstand Cold Resistance	Schmelz- integral I ² t _s Value	Kenn- zeichnung Marking	Approbationen Approvals
			mV	mΩ	A ² s		UL rec.
153000.0,5	500 mA	50 A @ DC 32 V	374	570	0,0009	F	✓
153000.0,63	630 mA	50 A @ DC 32 V	347	420	0,0014	CT	✓
153000.0,75	750 mA	50 A @ DC 32 V	280	285	0,0021	G	✓
153000.0,8	800 mA	50 A @ DC 32 V	262	250	0,0023	CV	✓
153000.1	1 A	50 A @ DC 32 V	243	185	0,0028	H	✓
153000.1,25	1,25 A	50 A @ DC 32 V	205	125	0,004	J	✓
153000.1,5	1,5 A	50 A @ DC 32 V	171	87	0,0059	K	✓
153000.1,6	1,6 A	50 A @ DC 32 V	164	78	0,0065	EF	✓
153000.1,75	1,75 A	50 A @ DC 32 V	161	70	0,0077	L	✓
153000.2	2 A	50 A @ DC 32 V	176	67	0,0101	N	✓
153000.2,5	2,5 A	50 A @ DC 32 V	131	40	0,0157	O	✓
153000.3	3 A	50 A @ DC 32 V	134	34	0,0227	P	✓
153000.3,15	3,15 A	50 A @ DC 32 V	128	31	0,025	EL	✓
153000.3,5	3,5 A	50 A @ DC 32 V	119	26	0,0308	R	✓
153000.4	4 A	50 A @ DC 32 V	105	20	0,0403	S	✓
153000.5	5 A	50 A @ DC 32 V	98	15	0,2275	T	✓

Type	Abk. Abbr.	Beschreibung Description
153000	GT-1K	1.000 Stück gegurtet / 1.000 pieces on tape
	GT-5K	5.000 Stück gegurtet / 5.000 pieces on tape
	GT-20K	20.000 Stück gegurtet / 20.000 pieces on tape
z.B./ e.g.	153000.1,75GT-1K	

Type
154000

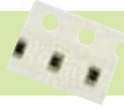

Zeit/Strom-Kennlinien
Time-Current Characteristics

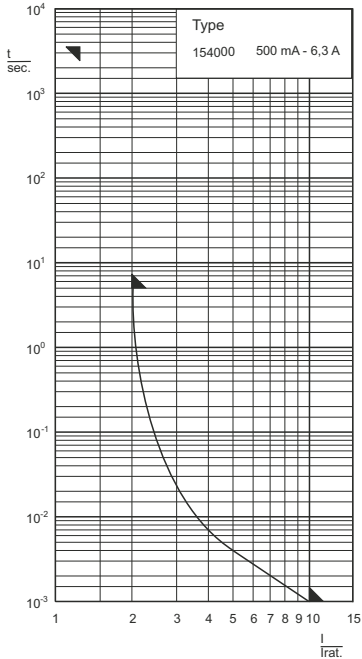

Aufbau / Construction

Keramiksubstrat / ceramic substrate
Schmelzleiter gedruckt / printed fuse-element

Lötwärmebeständigkeit /
resistance to soldering heat: 260 °C, 10 s (Lötbad / solder bath)
(nach IEC 60068-2-58 / to IEC 60068-2-58) 260 °C, 10 s (reflow)

Vibration / vibration: IEC 60068-2-6
Isolationswiderstand / insulation resistance IEC 60127-4

Schmelzeitgrenzwerte / Fusing time limits

Bemessungsstrom Rated Current	1 I _n		1,25 I _n		2 I _n		10 I _n	
	min.	min.	min.	max.	min.	max.	min.	max.
250 mA - 375 mA	1 h	-	-	5 s	-	200 ms	-	-
500 mA - 6,3 A	-	1 h	-	5 s	-	-	-	1 ms

UL 248-14 IEC 60127-4	1206 3,2 x 1,6 mm	63 V	FF superfink very quick acting
--------------------------	-----------------------------	------	--------------------------------------

Abmessungen
Dimensions

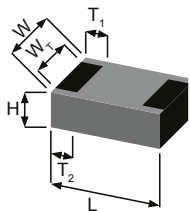

H	0,55 ± 0,1 mm
L	3,2 + 0,1 / - 0,2 mm
W	1,6 ± 0,15 mm
W _T	> 75% von/of W
T ₁	0,5 ± 0,25 mm
T ₂	0,3 ± 0,25 mm

Empfohlene Anschlussflächen
Recommended pad layout

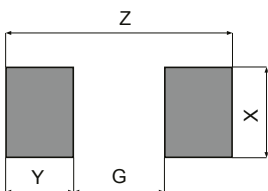

Lötung Soldering	Reflow Reflow	Welle Wave
G	1,5 mm	1,5 mm
X	1,75 mm	1,9 mm
Y	1,25 mm	1,6 mm
Z	4,0 mm	4,7 mm

Artikel-Nr. Article-no.	Bemessungs- strom Rated Current	Bemessungs- Ausschaltvermögen Rated Breaking Capacity	Spannungsfall Voltage Drop	Kalt- widerstand Cold Resistance	Schmelz- integral I ² t _z Value	Kenn- zeichnung Marking	Approbationen Approvals
			mV	mΩ	A ² s		UL rec. VDE
154000.0,25	250 mA	¹⁾	310	880	0.0001		listed
154000.0,375	375 mA	¹⁾	260	470	0.0004		listed
154000.0,5	500 mA	50 A @ DC 63 V ²⁾	433	660	0.0009	F	✓ ✓
154000.0,63	630 mA	50 A @ DC 63 V	372	450	0.0014	CT	✓ ✓
154000.0,75	750 mA	50 A @ DC 63 V	325	330	0.0022	G	✓ ✓
154000.0,8	800 mA	50 A @ DC 63 V	273	260	0.0023	CV	✓ ✓
154000.1	1 A	50 A @ DC 63 V ²⁾	262	200	0.0028	H	✓ ✓
154000.1,25	1,25 A	50 A @ DC 63 V	230	140	0.0041	J	✓ ✓
154000.1,5	1,5 A	50 A @ DC 63 V	207	105	0.0059	K	✓ ✓
154000.1,6	1,6 A	50 A @ DC 63 V ²⁾	168	80	0.0066	EF	✓ ✓
154000.1,75	1,75 A	50 A @ DC 63 V	174	76	0.0077	L	✓ ✓
154000.2	2 A	50 A @ DC 63 V ²⁾	181	69	0.0102	N	✓ ✓
154000.2,5	2,5 A	50 A @ DC 63 V	161	49	0.0159	O	✓ ✓
154000.3	3 A	50 A @ DC 63 V	173	44	0.0229	P	✓ ✓
154000.3,15	3,15 A	50 A @ DC 63 V ²⁾	153	37	0.0251	EL	✓ ✓
154000.3,5	3,5 A	50 A @ DC 63 V	161	35	0.0310	R	✓ ✓
154000.4	4 A	50 A @ DC 63 V	147	28	0.0404	S	✓ ✓
154000.5	5 A	50 A @ DC 63 V	131	20	0.2275	T	✓ ✓
154000.6,3	6,3 A	50 A @ DC 63 V	116	14	0.516	ET	✓ ✓

¹⁾ 50 A @ DC 63 V und 100 A @ AC 125 V
²⁾ 50 A @ DC 50 V mit/with VDE Approbation/approval

Type	Abk. Abbr.	Beschreibung Description
154000	GT-1K	1.000 Stück gegurtet / 1.000 pieces on tape
	GT-5K	5.000 Stück gegurtet / 5.000 pieces on tape
	GT-20K	20.000 Stück gegurtet / 20.000 pieces on tape
z.B./ e.g.		154000.6,3GT-5K

Type
157000

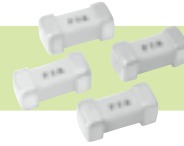

Zeit/Strom-Kennlinien
Time-Current Characteristics

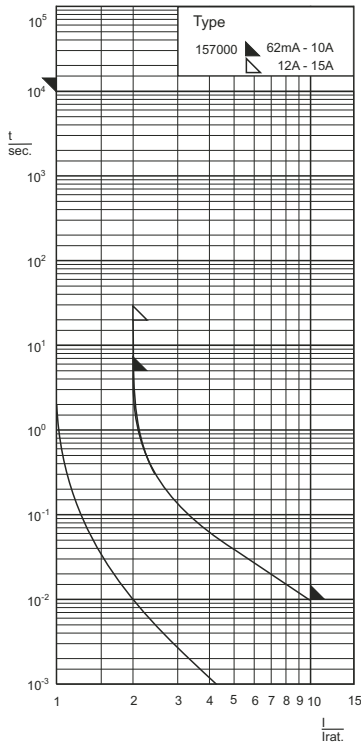

Abmessungen
Dimensions

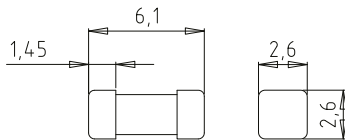

Empfohlene Anschlussflächen
Recommended pad layout

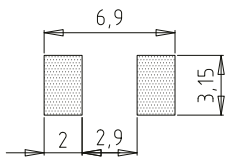

Aufbau / Construction

Isolierkörper / insulating body

Keramikrohr undurchsichtig /
ceramic tube non-transparent

Kontaktkappen / contact caps

Messing, versilbert / brass, silver-plated

Lötwärmebeständigkeit /
resistance to soldering heat:

260 °C, 10 s (nach IEC 60068 / to IEC 60068)

Schmelzeitgrenzwerte / Fusing time limits

Bemessungsstrom Rated Current	1 I _n		2,75 I _n		4 I _n		10 I _n	
	min.	max.	min.	max.	min.	max.	min.	max.
62 mA - 10 A	4 h	5 s	-	-	-	-	-	10 ms
12 - 15 A	4 h	20 s	-	-	-	-	-	10 ms

UL 248-14 CSA C22.s No. 248.14	2,6 x 6,1 mm	125 V 65 V	F flink quick acting
-----------------------------------	---------------------	---------------	----------------------------

Artikel-Nr. Article-no.	Bemessungs- strom Rated Current	Bemessungs- Ausschaltvermögen Rated Breaking Capacity	Spannungsfall Voltage Drop	Kaltwiderstand Cold Resistance	Schmelzintegral I ² t _c Value	Approbationen Approvals
			mV	mΩ	A ² s	UL rec.
157000.0,062	62 mA	50 A @ AC/DC 125 V	600	5500	0,00019	✓
157000.0,080	80 mA	50 A @ AC/DC 125 V	550	4050	0,00033	✓
157000.0,1	100 mA	50 A @ AC/DC 125 V	350	2000	0,0014	✓
157000.0,125	125 mA	50 A @ AC/DC 125 V	240	1500	0,0028	✓
157000.0,16	160 mA	50 A @ AC/DC 125 V	350	1400	0,0031	✓
157000.0,2	200 mA	50 A @ AC/DC 125 V	250	800	0,0066	✓
157000.0,25	250 mA	50 A @ AC/DC 125 V	230	600	0,011	✓
157000.0,315	315 mA	50 A @ AC/DC 125 V	210	420	0,023	✓
157000.0,375	375 mA	50 A @ AC/DC 125 V	180	300	0,043	✓
157000.0,4	400 mA	50 A @ AC/DC 125 V	180	290	0,048	✓
157000.0,5	500 mA	50 A @ AC/DC 125 V	180	230	0,073	✓
157000.0,63	630 mA	50 A @ AC/DC 125 V	180	190	0,12	✓
157000.0,75	750 mA	50 A @ AC/DC 125 V	170	160	0,18	✓
157000.0,8	800 mA	50 A @ AC/DC 125 V	160	130	0,26	✓
157000.1	1 A	50 A @ AC/DC 125 V	150	100	0,45	✓
157000.1,25	1,25 A	50 A @ AC/DC 125 V	150	78	0,68	✓
157000.1,5	1,5 A	50 A @ AC/DC 125 V	150	63	0,85	✓
157000.1,6	1,6 A	50 A @ AC/DC 125 V	140	58	1,05	✓
157000.2	2 A	50 A @ AC/DC 125 V	100	37	0,57	✓
157000.2,5	2,5 A	50 A @ AC/DC 125 V	100	28	1,1	✓
157000.3	3 A	50 A @ AC/DC 125 V	100	23	1,5	✓
157000.3,15	3,15 A	50 A @ AC/DC 125 V	100	21	1,9	✓
157000.3,5	3,5 A	50 A @ AC/DC 125 V	100	19	2,5	✓
157000.4	4 A	50 A @ AC/DC 125 V	100	16	3,3	✓
157000.5	5 A	50 A @ AC/DC 125 V	90	12,5	6,2	✓
157000.6,3	6,3 A	50 A @ AC/DC 125 V	90	10	9,1	✓
157000.7	7 A	50 A @ AC/DC 125 V	90	8,6	11	✓
157000.10	10 A	50 A @ AC/DC 65 V	90	5,9	27	✓
157000.12	12 A	50 A @ AC/DC 65 V	90	4,9	45	✓
157000.15	15 A	50 A @ AC/DC 65 V	90	3,8	81	✓

Type	Abk. Abbr.	Beschreibung Description
157000	-	100 Stück / pieces (5 Gurtabschnitte/tape sections von/of 20 Stück/pieces.)
	GT	1.500 Stück gegurtet / 1.500 pieces on tape
z.B./ e.g.		157000.3,15GT

Type
158000

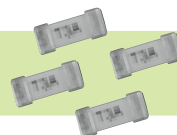

Zeit/Strom-Kennlinien
Time-Current Characteristics

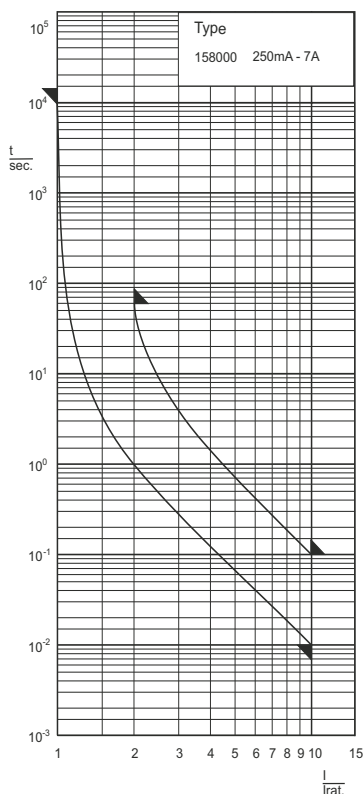

Abmessungen
Dimensions

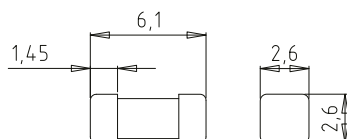

Empfohlene Anschlussflächen
Recommended pad layout

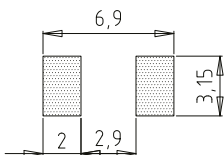

Aufbau / Construction

Isolierkörper / insulating body

Kontaktkappen / contact caps

Lötwärmebeständigkeit /
resistance to soldering heat:

Keramikrohr undurchsichtig /

ceramic tube non-transparent

Messing, versilbert / brass, silver-plated

260 °C, 10 s (nach IEC 60068 / to IEC 60068)

Schmelzeitgrenzwerte / Fusing time limits

Bemessungsstrom Rated Current	1 I _n		2 I _n		2,75 I _n		4 I _n		10 I _n	
	min.	max.	min.	max.	min.	max.	min.	max.	min.	max.
250 mA - 7 A	4 h	60 s	-	-	-	-	-	-	10 ms	100 ms

UL 248-14 CSA C22.2 No. 248.14	2,6 x 6,1 mm	125 V	T träge time-lag
-----------------------------------	---------------------	-------	------------------------

Artikel-Nr. Article-no.	Bemessungs- strom Rated Current	Bemessungs- Ausschaltvermögen Rated Breaking Capacity	Spannungsfall Voltage Drop	Kaltwiderstand Cold Resistance	Schmelz- integral I ² t ₉₀ Value	Approbationen Approvals
			mV	mΩ	A ² s	UL rec.
158000.0,25	250 mA	50 A @ AC/DC 125 V ¹⁾	280	900	0,08	✓ ¹⁾
158000.0,315	315 mA	50 A @ AC/DC 125 V ¹⁾	260	700	0,16	✓ ¹⁾
158000.0,375	375 mA	50 A @ AC/DC 125 V ¹⁾	230	500	0,35	✓ ¹⁾
158000.0,4	400 mA	50 A @ AC/DC 125 V ¹⁾	220	450	0,35	✓ ¹⁾
158000.0,5	500 mA	50 A @ AC/DC 125 V ¹⁾	200	300	1,0	✓ ¹⁾
158000.0,63	630 mA	50 A @ AC/DC 125 V ¹⁾	200	200	1,4	✓ ¹⁾
158000.0,75	750 mA	50 A @ AC/DC 125 V ¹⁾	190	170	1,5	✓ ¹⁾
158000.0,8	800 mA	50 A @ AC/DC 125 V ¹⁾	170	140	1,5	✓ ¹⁾
158000.1	1 A	50 A @ AC/DC 125 V ¹⁾	150	120	4,0	✓ ¹⁾
158000.1,25	1,25 A	50 A @ AC/DC 125 V ¹⁾	150	90	4,6	✓ ¹⁾
158000.1,5	1,5 A	50 A @ AC/DC 125 V ¹⁾	130	60	4,8	✓ ¹⁾
158000.1,6	1,6 A	50 A @ AC/DC 125 V ¹⁾	130	55	4,8	✓ ¹⁾
158000.2	2 A	50 A @ AC/DC 125 V ¹⁾	120	45	8,6	✓ ¹⁾
158000.2,5	2,5 A	50 A @ AC/DC 125 V ¹⁾	120	30	16	✓ ¹⁾
158000.3	3 A	50 A @ AC/DC 125 V ¹⁾	110	23	24	✓ ¹⁾
158000.3,15	3,15 A	50 A @ AC/DC 125 V ¹⁾	100	20	24	✓ ¹⁾
158000.3,5	3,5 A	50 A @ AC/DC 125 V ¹⁾	100	18	38	✓ ¹⁾
158000.4	4 A	50 A @ AC/DC 125 V ¹⁾	100	15	44	✓ ¹⁾
158000.5	5 A	50 A @ AC/DC 125 V ¹⁾	90	11	77	✓ ¹⁾
158000.6,3	6,3 A	50 A @ AC/DC 125 V ¹⁾	80	8	130	✓ ¹⁾
158000.7	7 A	50 A @ AC 125 V	90	8	130	✓ ¹⁾

¹⁾ 50 A @ AC 125 V und/and 50 A @ DC 65 V mit/with UL rec.

Type	Abk. Abbr.	Beschreibung Description
158000	-	100 Stück / pieces (5 Gurtabschnitte/tape sections von/of 20 Stück/pieces.)
	GT	1.500 Stück gegurtet / 1.500 pieces on tape
z.B./ e.g.	158000.2,5GT	

Type
160000

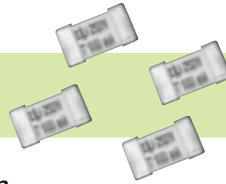

Zeit/Strom-Kennlinien
Time-Current Characteristics

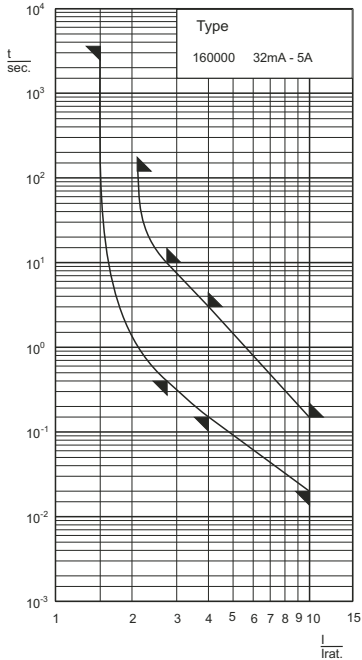

Abmessungen
Dimensions

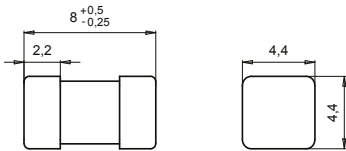

Empfohlene Anschlussflächen
Recommended pad layout

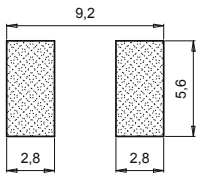

Aufbau / Construction

Isolierkörper / insulating body

Kontaktkappen / contact caps

Lötwärmebeständigkeit /
resistance to soldering heat:

Keramikrohr undurchsichtig /
ceramic tube non-transparent
Messing, versilbert / brass, silver-plated

260 °C, 10 s (Lötbad / solder bath)
(nach IEC 60068-2-58 / to IEC 60068-2-58)

Schmelzzeitgrenzwerte / Fusing time limits

Bemessungsstrom Rated Current	1,5 I _n		2,1 I _n		2,75 I _n		4 I _n		10 I _n	
	min.	max.	min.	max.	min.	max.	min.	max.	min.	max.
32 mA - 5 A	1 h	2 min	400 ms	10 s	150 ms	3 s	20 ms	150 ms		

IEC 60127	4,5 x 8 mm	250 V	T träge time-lag
-----------	-------------------	-------	------------------------

Artikel-Nr. Article-no.	Bemessungsstrom Rated Current	Bemessungs-Ausschaltvermögen Rated Breaking Capacity	Spannungsfall Voltage Drop	Leistungsabgabe Power Dissipation (@1,5 I _n)	Schmelzintegral I ² t ₅ Value	Approbationen Approvals
			mV	mW	A ² s	UL rec.
160000.0,032	32 mA	100 A @ AC 250 V ²⁾	1150	125	0,014	✓ ¹⁾
160000.0,04	40 mA	100 A @ AC 250 V ²⁾	860	150	0,013	✓ ¹⁾
160000.0,05	50 mA	100 A @ AC 250 V ²⁾	800	155	0,013	✓ ¹⁾
160000.0,063	63 mA	100 A @ AC 250 V ²⁾	580	160	0,02	✓ ¹⁾
160000.0,08	80 mA	100 A @ AC 250 V ²⁾	480	165	0,035	✓ ¹⁾
160000.0,1	100 mA	100 A @ AC 250 V ²⁾	350	170	0,06	✓ ¹⁾
160000.0,125	125 mA	100 A @ AC 250 V ²⁾	300	180	0,12	✓ ¹⁾
160000.0,16	160 mA	100 A @ AC 250 V ²⁾	280	190	0,21	✓ ¹⁾
160000.0,2	200 mA	100 A @ AC 250 V ²⁾	260	200	0,32	✓ ¹⁾
160000.0,25	250 mA	100 A @ AC 250 V ²⁾	240	220	0,5	✓ ¹⁾
160000.0,315	315 mA	100 A @ AC 250 V ³⁾	220	250	0,8	✓ ¹⁾
160000.0,4	400 mA	100 A @ AC 250 V ³⁾	200	280	1,1	✓ ¹⁾
160000.0,5	500 mA	100 A @ AC 250 V ³⁾	190	310	1,8	✓ ¹⁾
160000.0,63	630 mA	100 A @ AC 250 V ³⁾	180	360	3,2	✓ ¹⁾
160000.0,8	800 mA	100 A @ AC 250 V ³⁾	160	430	5,2	✓ ¹⁾
160000.1	1 A	100 A @ AC 250 V ³⁾	140	500	6,8	✓ ¹⁾
160000.1,25	1,25 A	100 A @ AC 250 V ³⁾	130	600	12	✓ ¹⁾
160000.1,6	1,6 A	100 A @ AC 250 V ³⁾	120	730	22	✓ ¹⁾
160000.2	2 A	100 A @ AC 250 V ³⁾	100	870	30	✓ ¹⁾
160000.2,5	2,5 A	100 A @ AC 250 V ³⁾	100	1000	46	✓ ¹⁾
160000.3,15	3,15 A	100 A @ AC 250 V ³⁾	100	1200	80	✓ ¹⁾
160000.4	4 A	100 A @ AC 250 V ³⁾	100	1400	130	✓ ¹⁾
160000.5	5 A	100 A @ AC 250 V ³⁾	100	1700	130	✓ ¹⁾

¹⁾ 100A @ AC 250V und/and 100 A @ DC 72 V mit/with UL rec.

²⁾ 1500 A @ DC 24V und/and 100 A @ DC 125 V

³⁾ 1500 A @ DC 24V

Type	Abk. Abbr.	Beschreibung Description
160000	-	100 Stück / pieces (5 Gurtabschnitte/tape sections von/of 20 Stück/pieces.)
	GT	1.500 Stück gegurtet / 1.500 pieces on tape
	z.B./ e.g.	160000.0,5GT

Type
160500



Zeit/Strom-Kennlinien
Time-Current Characteristics

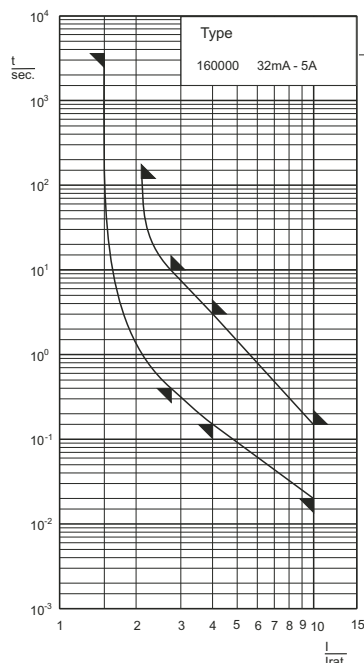

Abmessungen
Dimensions

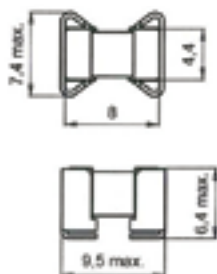

Empfohlene Anschlussflächen
Recommended pad layout

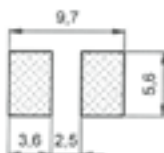

Aufbau / Construction

Isolierkörper / insulating body

Keramikrohr undurchsichtig /
ceramic tube non-transparent

Kontaktkappen / contact caps

Messing, versilbert / brass, silver-plated

Sicherungs Clip / Fuse Clip

Bronze verzinkt / bronze, tin plated

Lötwärmebeständigkeit /
resistance to soldering heat:

260 °C, 10 s (nach IEC 60068/ to IEC 60068)

Schmelzeitgrenzwerte / Fusing time limits

Bemessungsstrom Rated Current	1,5 I _n		2,1 I _n		2,75 I _n		4 I _n		10 I _n	
	min.	max.	min.	max.	min.	max.	min.	max.	min.	max.
32 mA - 5 A	1 h	2 min	400 ms	10 s	150 ms	3 s	20 ms	150 ms		

IEC 60127	4,5 x 8 mm	250 V	T träge time-lag
-----------	-------------------	-------	------------------------

Artikel-Nr. Article-no.	Bemessungs- strom Rated Current	Bemessungs- Ausschaltvermögen Rated Breaking Capacity	Spannungsfall Voltage Drop	Leistungsabgabe Power Dissipa- tion (@1,5 I _n)	Schmelzintegral I ² t ₅ Value	Approbationen Approvals
			mV	mW	A ² s	UL rec.
160500.0,032	32 mA	100 A @ AC 250 V ²⁾	1150	125	0,014	✓ ¹⁾
160500.0,04	40 mA	100 A @ AC 250 V ²⁾	860	150	0,013	✓ ¹⁾
160500.0,05	50 mA	100 A @ AC 250 V ²⁾	800	155	0,013	✓ ¹⁾
160500.0,063	63 mA	100 A @ AC 250 V ²⁾	580	160	0,02	✓ ¹⁾
160500.0,08	80 mA	100 A @ AC 250 V ²⁾	480	165	0,035	✓ ¹⁾
160500.0,1	100 mA	100 A @ AC 250 V ²⁾	350	170	0,06	✓ ¹⁾
160500.0,125	125 mA	100 A @ AC 250 V ²⁾	300	180	0,12	✓ ¹⁾
160500.0,16	160 mA	100 A @ AC 250 V ²⁾	280	190	0,21	✓ ¹⁾
160500.0,2	200 mA	100 A @ AC 250 V ²⁾	260	200	0,32	✓ ¹⁾
160500.0,25	250 mA	100 A @ AC 250 V ²⁾	240	220	0,5	✓ ¹⁾
160500.0,315	315 mA	100 A @ AC 250 V ³⁾	220	250	0,8	✓ ¹⁾
160500.0,4	400 mA	100 A @ AC 250 V ³⁾	200	280	1,1	✓ ¹⁾
160500.0,5	500 mA	100 A @ AC 250 V ³⁾	190	310	1,8	✓ ¹⁾
160500.0,63	630 mA	100 A @ AC 250 V ³⁾	180	360	3,2	✓ ¹⁾
160500.0,8	800 mA	100 A @ AC 250 V ³⁾	160	430	5,2	✓ ¹⁾
160500.1	1 A	100 A @ AC 250 V ³⁾	140	500	6,8	✓ ¹⁾
160500.1,25	1,25 A	100 A @ AC 250 V ³⁾	130	600	12	✓ ¹⁾
160500.1,6	1,6 A	100 A @ AC 250 V ³⁾	120	730	22	✓ ¹⁾
160500.2	2 A	100 A @ AC 250 V ³⁾	100	870	30	✓ ¹⁾
160500.2,5	2,5 A	100 A @ AC 250 V ³⁾	100	1000	46	✓ ¹⁾
160500.3,15	3,15 A	100 A @ AC 250 V ³⁾	100	1200	80	✓ ¹⁾
160500.4	4 A	100 A @ AC 250 V ³⁾	100	1400	130	✓ ¹⁾
160500.5	5 A	100 A @ AC 250 V ³⁾	100	1700	130	✓ ¹⁾

¹⁾ 100A @ AC 250V und/and 100 A @ DC 72 V mit/with UL rec.

²⁾ 1500 A @ DC 24V und/and 100 A @ DC 125 V

³⁾ 1500 A @ DC 24V

Type	Abk. Abbr.	Beschreibung Description
160500	-	100 Stück / pieces (5 Gurtabschnitte/tape sections von/of 20 Stück/pieces)
	GT	800 Stück gegurtet / 800 pieces on tape

Type
161000

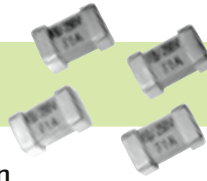

Zeit/Strom-Kennlinien
Time-Current Characteristics

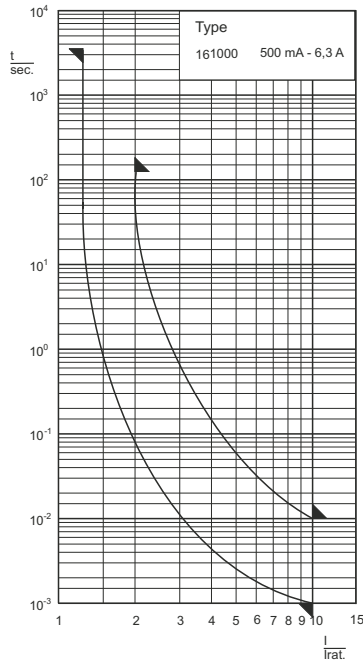

Abmessungen
Dimensions

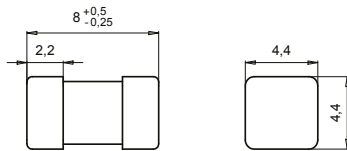

Empfohlene Anschlussflächen
Recommended pad layout

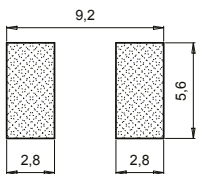

Aufbau / Construction
Keramikrohr / ceramic tube

Kontaktkappen / contact caps

Lötwärmebeständigkeit /
resistance to soldering heat:

undurchsichtig mit Löschmittelfüllung /
non-transparent / with filling

Messing, versilbert / brass, silver-plated

260 °C, 10 s (Lötbad / solder bath)
(nach IEC 60068-2-58 / to IEC 60068-2-58)

Schmelzeitgrenzwerte / Fusing time limits

Bemessungsstrom Rated Current	1,25 I _n		2 I _n		2,75 I _n		4 I _n		10 I _n	
	min.	max.	min.	max.	min.	max.	min.	max.	min.	max.
500 mA - 6,3 A	1 h	120 s	-	-	-	-	-	-	1 ms	10 ms

IEC 60127-4	4,5 x 8 mm	250 V	F flink quick acting
-------------	-------------------	-------	----------------------------

Artikel-Nr. Article-no.	Bemessungs- strom Rated Current	Bemessungs- Ausschaltvermögen Rated Breaking Capacity	Spannungsfall Voltage Drop	Leistungsabgabe Power Dissipa- tion (@1,25I _n)	Schmelzintegral I ² t _s Value	Approbationen Approvals
			mV	mW	A ² s	
161000.0,5	500 mA	100 A @ AC 250V	200	300	0.076	
161000.0,63	630 mA	100 A @ AC 250V	180	300	0.19	
161000.0,8	800 mA	100 A @ AC 250V	160	300	0.38	
161000.1	1 A	100 A @ AC 250V	140	300	0.71	
161000.1,25	1,25 A	100 A @ AC 250V	140	400	0.94	
161000.1,6	1,6 A	100 A @ AC 250V	120	400	0.56	
161000.2	2 A	100 A @ AC 250V	110	500	1.1	
161000.2,5	2,5 A	100 A @ AC 250V	100	600	2.0	
161000.3,15	3,15 A	100 A @ AC 250V	100	700	3.2	
161000.4	4 A	100 A @ AC 250V	100	900	5.0	
161000.5	5 A	100 A @ AC 250V	100	1000	9.0	
161000.6,3	6,3 A	100 A @ AC 250V	100	1400	13	

Type	Abk. Abbr.	Beschreibung Description
161000	-	100 Stück / pieces (5 Gurtabschnitte/tape sections von/of 20 Stück/pieces.)
	GT	1.500 Stück gegurtet / 1.500 pieces on tape
z.B./ e.g.	161000.1,6GT	

Type
160016



Zeit/Strom-Kennlinien
Time-Current Characteristics

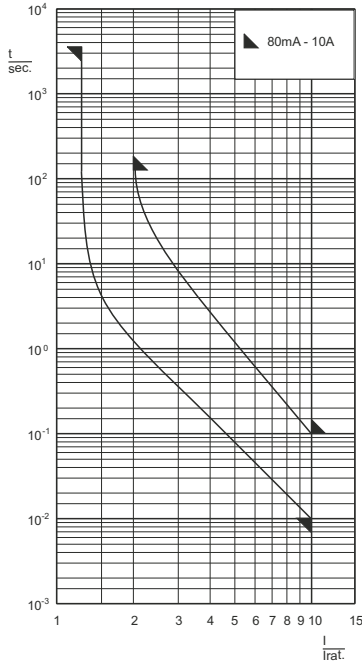

Abmessungen
Dimensions

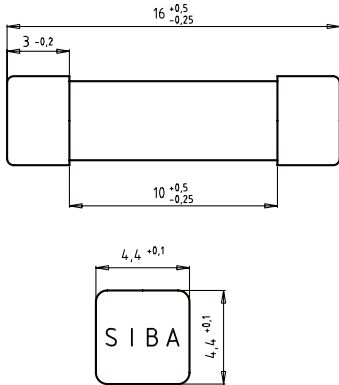

Empfohlene Anschlussflächen
Recommended pad layout

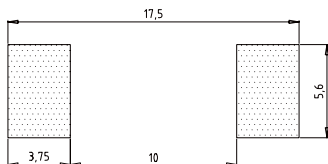

Aufbau / Construction

Isolierkörper / insulating body

Kontaktkappen / contact caps

Lötwärmebeständigkeit /
resistance to soldering heat:

Keramikrohr mit Füllung /

ceramic tube with filling

Kupferlegierung, versilbert / copper-alloy,
silver-plated

260 °C, 10 s (nach IEC 60068 / to IEC 60068)

Schmelzeitgrenzwerte / Fusing time limits

Bemessungsstrom Rated Current	1,25 I _N		2 I _N		2,75 I _N		4 I _N		10 I _N	
	min.	max.	min.	max.	min.	max.	min.	max.	min.	max.
80 mA - 10 A	1 h	2 min	-	-	-	-	-	-	10 ms	100 ms

IEC 60127-4/2 UL 248-14	4,5 x 16 mm	250 V	T träge time-lag
----------------------------	--------------------	-------	------------------------

Artikel-Nr. Article-no.	Bemessungs- strom Rated Current	Bemessungs- Ausschaltvermögen Rated Breaking Capacity	Spannungsfall Voltage Drop	Leistungsabgabe Power Dissipa- tion (@ 1,25 I _N)	Schmelzintegral I ² t ₅ Value (@ 10 I _N)	Approbationen Approvals	
			mV	mW	A ² s	Semko	UL rec
160016.0,05	50 mA	1500 A @ AC 305 V ¹⁾	2600	260	0,010	✓	✓
160016.0,08	80 mA	1500 A @ AC 305 V ¹⁾	2050	270	0,025	✓	✓
160016.0,1	100 mA	1500 A @ AC 305 V ¹⁾	1750	290	0,030	✓	✓
160016.0,125	125 mA	1500 A @ AC 305 V ¹⁾	1430	310	0,055	✓	✓
160016.0,16	160 mA	1500 A @ AC 305 V ¹⁾	1220	340	0,065	✓	✓
160016.0,2	200 mA	1500 A @ AC 305 V ¹⁾	960	350	0,11	✓	✓
160016.0,25	250 mA	1500 A @ AC 305 V ¹⁾	840	360	0,19	✓	✓
160016.0,315	315 mA	1500 A @ AC 305 V ¹⁾	700	380	0,34	✓	✓
160016.0,4	400 mA	1500 A @ AC 305 V ¹⁾	570	400	0,54	✓	✓
160016.0,5	500 mA	1500 A @ AC 305 V ¹⁾	490	430	0,86	✓	✓
160016.0,63	630 mA	1500 A @ AC 305 V ¹⁾	410	460	1,5	✓	✓
160016.0,8	800 mA	1500 A @ AC 305 V ¹⁾	350	490	2,6	✓	✓
160016.1	1 A	1500 A @ AC 305 V ¹⁾	380	640	4,5	✓	✓
160016.1,25	1,25 A	1500 A @ AC 305 V ¹⁾	340	790	4,1	✓	✓
160016.1,6	1,6 A	1500 A @ AC 305 V ¹⁾	330	970	6,2	✓	✓
160016.2	2 A	1500 A @ AC 305 V ¹⁾	280	1060	13	✓	✓
160016.2,5	2,5 A	1500 A @ AC 305 V ¹⁾	240	1120	21	✓	✓
160016.3,15	3,15 A	1500 A @ AC 305 V ¹⁾	200	1200	35	✓	✓
160016.4	4 A	1500 A @ AC 305 V ¹⁾	160	1250	49	✓	✓
160016.5	5 A	1500 A @ AC 277 V ¹⁾	140	1300	92	✓	✓
160016.6,3	6,3 A	1500 A @ AC 277 V ¹⁾	120	1370	170	✓	✓
160016.8	8 A	1500 A @ AC 250 V ¹⁾	90	1250	160	✓	✓
160016.10	10 A	1500 A @ AC 250 V ¹⁾	80	1500	280	✓	✓

¹⁾ 1500A @ DC 250V

Sonderausschaltvermögen - special breaking capacity 4000A @ AC 250V cosφ = 0,7-0,8

Type	Abk. Abbr.	Beschreibung Description
160016	-	100 Stück / pieces (5 Gurtabschnitte/tape sections von/of 20 Stück/pieces.)
	GT	1.500 Stück gegurtet / 1.500 pieces on tape
z.B./ e.g.	160016.1,25GT	

Type
160516



Zeit/Strom-Kennlinien
Time-Current Characteristics

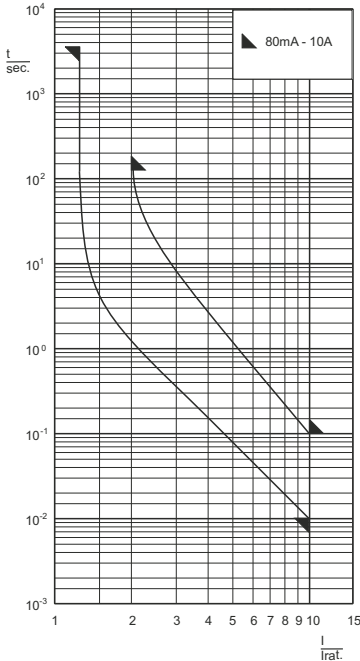

Abmessungen
Dimensions

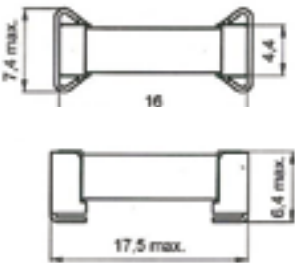

Empfohlene Anschlussflächen
Recommended pad layout



Aufbau / Construction
Isolierkörper / insulating body

Keramikrohr mit Füllung / ceramic tube with filling

Kontaktkappen / contact caps
Sicherungs Clip / Fuse Clip
Lötwärmebeständigkeit /
resistance to soldering heat:

Kupferlegierung, versilbert / copper-alloy, silver-plated
Bronze, verzinkt / bronze, tin plated
260 °C, 10 s (nach IEC 60068 / to IEC 60068)

Schmelzeitgrenzwerte / Fusing time limits

Bemessungsstrom Rated Current	1,25 I _N		2 I _N		2,75 I _N		4 I _N		10 I _N	
	min.	max.	min.	max.	min.	max.	min.	max.	min.	max.
80 mA - 10 A	1 h	2 min	-	-	-	-	-	-	10 ms	100 ms

IEC 60127-4/2 UL 248-14	4,5 x 16 mm	250 V	T träge time-lag
----------------------------	--------------------	-------	------------------------

Artikel-Nr. Article-no.	Bemessungs- strom Rated Current	Bemessungs- Ausschaltvermögen Rated Breaking Capacity	Spannungsfall Voltage Drop	Leistungsabgabe Power Dissipa- tion (@ 1,25 I _N)	Schmelzintegral I ² t ₅ Value (@ 10 I _N)	Approbationen Approvals	
			mV	mW	A ² s	Semko	UL rec
160516.0,05	50 mA	1500 A @ AC 305 V ¹⁾	2600	260	0,010	✓	✓
160516.0,08	80 mA	1500 A @ AC 305 V ¹⁾	2050	270	0,025	✓	✓
160516.0,1	100 mA	1500 A @ AC 305 V ¹⁾	1750	290	0,030	✓	✓
160516.0,125	125 mA	1500 A @ AC 305 V ¹⁾	1430	310	0,055	✓	✓
160516.0,16	160 mA	1500 A @ AC 305 V ¹⁾	1220	340	0,065	✓	✓
160516.0,2	200 mA	1500 A @ AC 305 V ¹⁾	960	350	0,11	✓	✓
160516.0,25	250 mA	1500 A @ AC 305 V ¹⁾	840	360	0,19	✓	✓
160516.0,315	315 mA	1500 A @ AC 305 V ¹⁾	700	380	0,34	✓	✓
160516.0,4	400 mA	1500 A @ AC 305 V ¹⁾	570	400	0,54	✓	✓
160516.0,5	500 mA	1500 A @ AC 305 V ¹⁾	490	430	0,86	✓	✓
160516.0,63	630 mA	1500 A @ AC 305 V ¹⁾	410	460	1,5	✓	✓
160516.0,8	800 mA	1500 A @ AC 305 V ¹⁾	350	490	2,6	✓	✓
160516.1	1 A	1500 A @ AC 305 V ¹⁾	380	640	4,5	✓	✓
160516.1,25	1,25 A	1500 A @ AC 305 V ¹⁾	340	790	4,1	✓	✓
160516.1,6	1,6 A	1500 A @ AC 305 V ¹⁾	330	970	6,2	✓	✓
160516.2	2 A	1500 A @ AC 305 V ¹⁾	280	1060	13	✓	✓
160516.2,5	2,5 A	1500 A @ AC 305 V ¹⁾	240	1120	21	✓	✓
160516.3,15	3,15 A	1500 A @ AC 305 V ¹⁾	200	1200	35	✓	✓
160516.4	4 A	1500 A @ AC 305 V ¹⁾	160	1250	49	✓	✓
160516.5	5 A	1500 A @ AC 277 V ¹⁾	140	1300	92	✓	✓
160516.6,3	6,3 A	1500 A @ AC 277 V ¹⁾	120	1370	170	✓	✓
160516.8	8 A	1500 A @ AC 250 V ¹⁾	90	1250	160	✓	✓
160516.10	10 A	1500 A @ AC 250 V ¹⁾	80	1500	280	✓	✓

¹⁾ 1500A @ DC 250V
Sonderausschaltvermögen - special breaking capacity 4000A @ AC 250V cosφ = 0,7-0,8

Type	Abk. Abbr.	Beschreibung Description
160516	-	100 Stück / pieces (5 Gurtabschnitte/tape sections von/of 20 Stück/pieces.)
	GT	800 Stück gegurtet / 800 pieces on tape
z.B./ e.g.	160516.1,25GT	

**Type
163016**



**Zeit/Strom-Kennlinien
Time-Current Characteristics**

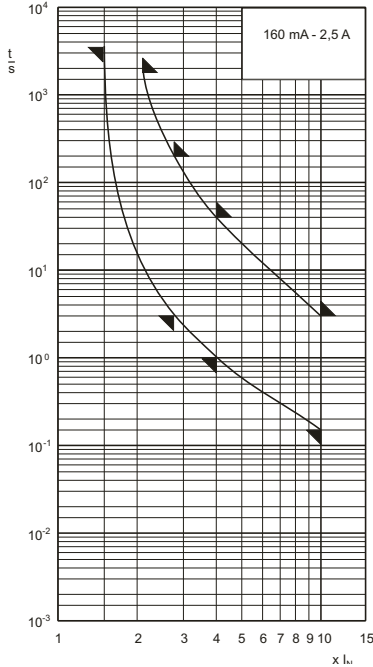

**Abmessungen
Dimensions**

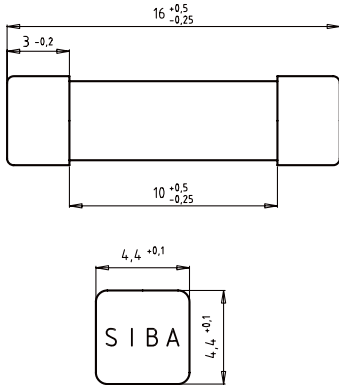

**Empfohlene Anschlussflächen
Recommended pad layout**

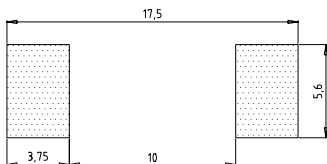

Aufbau / Construction

Isolierkörper / insulating body

Keramikkrohr / ceramic tube

Kontaktkappen / contact caps

Kupferlegierung, versilbert / copper-alloy, silver-plated

Lötwärmebeständigkeit /
resistance to soldering heat:

260 °C, 10 s (nach IEC 60068 / to IEC 60068)

Schmelzeitgrenzwerte / Fusing time limits

Bemessungsstrom Rated Current	1,5 I _N		2,1 I _N		2,75 I _N		4 I _N		10 I _N	
	min.	max.	min.	max.	min.	max.	min.	max.	min.	max.
160 mA - 2,5 A	1 h	30 min	3 s	200 s	1 s	40 s	150 ms	3 s		

(IEC 60127-4)	4,5 x 16 mm	250 V	TT superträge very time-lag
---------------	--------------------	-------	-----------------------------------

Artikel-Nr. Article-no.	Bemessungs- strom Rated Current	Bemessungs- Ausschaltvermögen Rated Breaking Capacity	Spannungsfall Voltage Drop	Leistungsabgabe Power Dissipa- tion (@ 1,5 I _N)	Schmelzintegral I ² t _s Value (@ 10 I _N)	Approbationen Approvals
			mV	mW	A ² s	
163016.0,16GT	160 mA	35 A @ AC 250 V	?)	?)	?)	
163016.0,2GT	200 mA	35 A @ AC 250 V	?)	?)	?)	
163016.0,25GT	250 mA	35 A @ AC 250 V	?)	?)	?)	
163016.0,315GT	315 mA	35 A @ AC 250 V	?)	?)	?)	
163016.0,4GT	400 mA	35 A @ AC 250 V	190	190	4,5	
163016.0,5GT	500 mA	35 A @ AC 250 V	?)	?)	?)	
163016.0,63GT	630 mA	35 A @ AC 250 V	?)	?)	?)	
163016.0,8GT	800 mA	35 A @ AC 250 V	160	350	14	
163016.1GT	1 A	35 A @ AC 250 V	160	550	23	
163016.2GT	2 A	35 A @ AC 250 V	80	500	80	
163016.2,5GT	2,5 A	35 A @ AC 250 V	?)	?)	?)	

?) Auf Anfrage / upon request

Type	Abk. Abbr.	Beschreibung Description
	GT	1.500 Stück gegurtet / 1.500 pieces on tape

Neu / New

Type
160020



Zeit/Strom-Kennlinien
Time-Current Characteristics

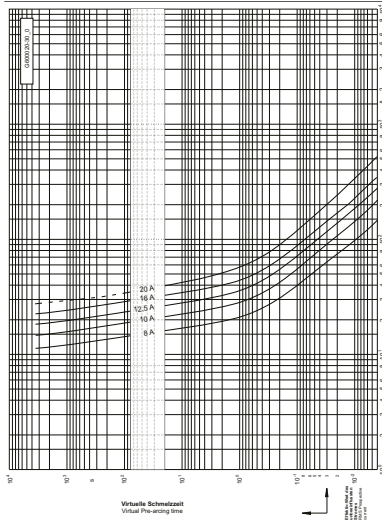

Aufbau / Construction

Isolierkörper / insulating body

Kontaktdeckeln / contact caps

Lötwärmebeständigkeit /
resistance to soldering heat:

Keramikrohr mit Füllung /
ceramic tube with filling

Kupferlegierung, versilbert / copper-alloy,
silver-plated

260 °C, 10 s (nach IEC 60068 / to IEC 60068)

Schmelzeitgrenzwerte / Fusing time limits

Bemessungsstrom Rated Current	1,25 I _N		2 I _N		2,75 I _N		4 I _N		10 I _N	
	min.	max.	min.	max.	min.	max.	min.	max.	min.	max.
8 A - 16 A	1 h	120 s	-	-	-	-	-	-	10 ms	100 ms
20 A	-	120 s	-	-	-	-	-	-	10 ms	100 ms

IEC 60127-7	5,8 x 20 mm	250 V	T träge time-lag
-------------	--------------------	-------	------------------------

Abmessungen
Dimensions

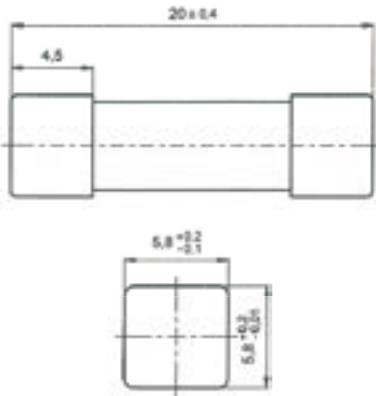

Empfohlene Anschlussflächen
Recommended pad layout

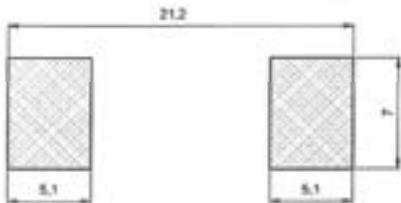

Artikel-Nr. Article-no.	Bemessungs- strom Rated Current	Bemessungs- Ausschaltvermögen Rated Breaking Capacity	Spannungsfall Voltage Drop	Leistungsabgabe Power Dissipa- tion (@ 1,25 I _N)	Schmelzintegral I ² t ₉₀ Value (@ 10 I _N)	Approbationen Approvals	
			mV	mW	A ² s	Semko	UL rec
160020.8	8 A	1500 A @ AC 277 V ¹⁾	105	1550	110	✓	✓
160020.10	10 A	1500 A @ AC 277 V ¹⁾	90	1650	240	✓	✓
160020.12,5	12,5 A	1500 A @ AC 277 V ¹⁾	95	2150	400	✓	✓
160020.16	16 A	1500 A @ AC 277 V ¹⁾	100	3800	630	✓	✓
160020.20	20 A	1500 A @ AC 250 V ¹⁾	110	2200 ²⁾	1200	³⁾	✓

¹⁾ 1500A @ DC 250V
²⁾ Leistungsabgabe / Powerloss @ 1,0xI_N
³⁾ In Vorbereitung / In preparation

Type	Abk. Abbr.	Beschreibung Description
160020	-	100 Stück / pieces
	GT	800 Stück gegurtet / 800 pieces on tape
	z.B./ e.g.	160020.12,5GT

Type
164000



Type
164050

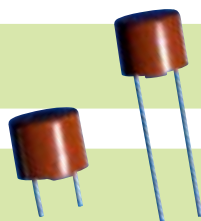

Zeit/Strom-Kennlinien
Time-Current Characteristics

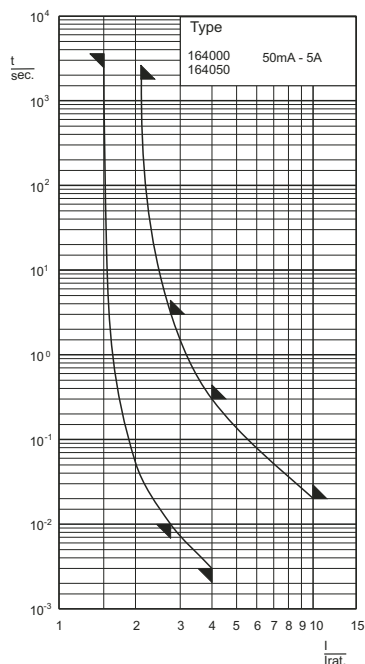

Aufbau / Construction

Gehäuse / body

Thermoplast, braun / thermoplastic, brown
temperaturbeständig / temperature resistant
selbstverlöschend / self-extinguishing

Anschlussstifte / terminations

0,6 mm Ø, verzinkt / tinned
löt- oder steckbar / solder or plug

Zubehör / Related Products

Sicherungs-Halter / fuse-holder 166602

siehe Seite 74 / see page 74

Schmelzzeitgrenzwerte / Fusing time limits

Bemessungsstrom Rated Current	1,5 I _n		2,1 I _n		2,75 I _n		4 I _n		10 I _n	
	min.	max.	min.	max.	min.	max.	min.	max.	min.	max.
50 mA - 6,3 A	1 h	30 min	10 ms	3 s	3 ms	300 ms	-	20 ms		

IEC 60127-3/3 EN 60127-3/3 VDE 0820-3/3	8,4 x 7,6 mm	250 V	F flink quick acting
---	---------------------	-------	----------------------------

Abmessungen
Dimensions

164000 (x=0 lange Stifte/long pins)

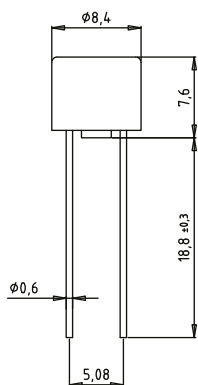

164050 (x=5 kurze Stifte/short pins)

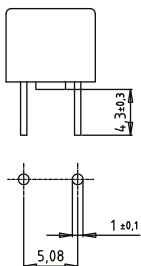

Artikel-Nr. Article-no.	Bemessungsstrom Rated Current	Bemessungs-Ausschaltvermögen Rated Breaking Capacity	Spannungsfall Voltage Drop	Leistungsabgabe Power Dissipation (@1,5 I _n)	Schmelzintegral I ² t ₅₀ Value	Approbationen Approvals	
						Semko	UL rec.
1640x0.0,05	50 mA	35 A @ AC 250 V	820	95	0,0003	✓	✓
1640x0.0,063	63 mA	35 A @ AC 250 V	750	110	0,0007	✓	✓
1640x0.0,08	80 mA	35 A @ AC 250 V	630	120	0,0015	✓	✓
1640x0.0,1	100 mA	35 A @ AC 250 V	550	155	0,0035	✓	✓
1640x0.0,125	125 mA	35 A @ AC 250 V	500	175	0,006	✓	✓
1640x0.0,16	160 mA	35 A @ AC 250 V	460	210	0,011	✓	✓
1640x0.0,2	200 mA	35 A @ AC 250 V	150	80	0,018	✓	✓
1640x0.0,25	250 mA	35 A @ AC 250 V	140	90	0,036	✓	✓
1640x0.0,315	315 mA	35 A @ AC 250 V	130	120	0,05	✓	✓
1640x0.0,4	400 mA	35 A @ AC 250 V	120	140	0,10	✓	✓
1640x0.0,5	500 mA	35 A @ AC 250 V	110	160	0,18	✓	✓
1640x0.0,63	630 mA	35 A @ AC 250 V	100	180	0,33	✓	✓
1640x0.0,8	800 mA	35 A @ AC 250 V	90	200	0,14	✓	✓
1640x0.1	1 A	35 A @ AC 250 V	80	220	0,24	✓	✓
1640x0.1,25	1,25 A	35 A @ AC 250 V	75	260	0,35	✓	✓
1640x0.1,6	1,6 A	35 A @ AC 250 V	70	350	0,6	✓	✓
1640x0.2	2 A	35 A @ AC 250 V	65	380	1,2	✓	✓
1640x0.2,5	2,5 A	35 A @ AC 250 V	60	420	2,0	✓	✓
1640x0.3,15	3,15 A	35 A @ AC 250 V	60	580	3,5	✓	✓
1640x0.4	4 A	40 A @ AC 250 V	60	700	6,2	✓	✓
1640x0.5	5 A	50 A @ AC 250 V	60	900	13	✓	✓
1640x0.6,3	6,3 A ¹⁾	63 A @ AC 250 V	60	1100	19	✓	✓

x = 0 lange Stifte / long pins

x = 5 kurze Stifte / short pins

¹⁾ Zusätzlich lieferbare Bemessungsströme / Non-standard ratings also available

Type	Abk. Abbr.	Beschreibung Description
164000/164050	-	100 Stück / pieces
164000	GT	1.000 Stück gegurtet / 1.000 pieces on tape
164050	IP	2.000 Stück Industrieverpackung / 2.000 industrial packs
z.B./ e.g. 164000,3,15GT		

Type
164500



Type
164550

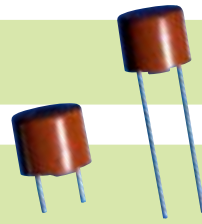

Zeit/Strom-Kennlinien
Time-Current Characteristics

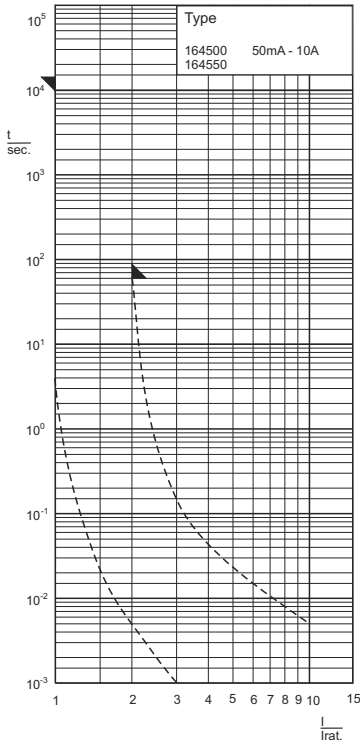

Abmessungen
Dimensions
164500 (x=0 lange Stifte/long pins)

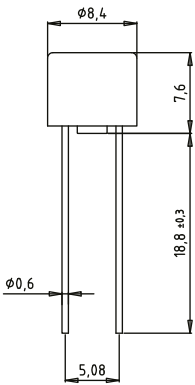

164550 (x=5 kurze Stifte/short pins)

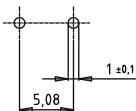
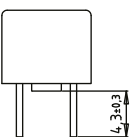

Aufbau / Construction

Gehäuse / body

Thermoplast, braun / thermoplastic, brown
temperaturbeständig / temperature resistant
selbstverlöschend / self-extinguishing

Anschlussstifte / terminations

0,6 mm Ø, verzinkt / tinned
löt- oder steckbar / solder or plug

Zubehör / Related Products

Halter / holder 166602

siehe Seite 74 / see page 74

Schmelzeitgrenzwerte / Fusing time limits

Bemessungsstrom Rated Current	100% I _n		135% I _n		150% I _n		200% I _n	
	min.	max.	min.	max.	min.	max.	min.	max.
50 mA - 10 A	4 h	-	-	-	-	-	-	60 s

UL 248-14 CSA C22.2 No. 248.14	8,4 x 7,6 mm	250 V	F flink quick acting
-----------------------------------	---------------------	-------	----------------------------

Artikel-Nr. Article-no.	Bemessungsstrom Rated Current	Bemessungs-Ausschaltvermögen Rated Breaking Capacity	Spannungsfall Voltage Drop	Leistungsabgabe Power Dissipation (@1,0 I _n)	Schmelzintegral I ² t ₅ Value	Approbationen Approvals
			mV	mW	A ² s	UL
1645x0,05	50 mA	50 A @ AC 250 V	2400	120	0,0001	✓
1645x0,063	63 mA	50 A @ AC 250 V	1350	85	0,0003	✓
1645x0,08	80 mA	50 A @ AC 250 V	1200	95	0,0007	✓
1645x0,1	100 mA	50 A @ AC 250 V	1100	110	0,0015	✓
1645x0,125	125 mA	50 A @ AC 250 V	1000	125	0,003	✓
1645x0,16	160 mA	50 A @ AC 250 V	950	155	0,0075	✓
1645x0,2	200 mA	50 A @ AC 250 V	850	170	0,013	✓
1645x0,25	250 mA	50 A @ AC 250 V	240	60	0,02	✓
1645x0,315	315 mA	50 A @ AC 250 V	230	75	0,03	✓
1645x0,4	400 mA	50 A @ AC 250 V	220	90	0,055	✓
1645x0,5	500 mA	50 A @ AC 250 V	210	105	0,1	✓
1645x0,63	630 mA	50 A @ AC 250 V	200	130	0,19	✓
1645x0,8	800 mA	50 A @ AC 250 V	190	155	0,36	✓
1645x0,1	1 A	50 A @ AC 250 V	180	180	0,14	✓
1645x0,1,25	1,25 A	50 A @ AC 250 V	170	215	0,24	✓
1645x0,1,6	1,6 A	50 A @ AC 250 V	160	260	0,34	✓
1645x0,2	2 A	50 A @ AC 250 V	150	300	0,56	✓
1645x0,2,5	2,5 A	50 A @ AC 250 V	140	350	1,1	✓
1645x0,3,15	3,15 A	50 A @ AC 250 V	130	410	2	✓
1645x0,4	4 A	50 A @ AC 250 V	120	480	3,2	✓
1645x0,5	5 A	50 A @ AC 250 V	110	550	6,2	✓
1645x0,6,3	6,3 A	50 A @ AC 250 V	100	630	14	✓
1645x0,8	8 A	50 A @ AC 250 V	90	720	24	✓
1645x0,10	10 A	50 A @ AC 250 V	90	900	40	✓

x = 0 lange Stifte / long pins

x = 5 kurze Stifte / short pins

Type	Abk. Abbr.	Beschreibung Description
164500/164550	-	100 Stück / pieces
164500	GT	1.000 Stück gegurtet / 1.000 pieces on tape
164550	IP	2.000 Stück Industrieverpackung / 2.000 industrial packs
z.B./ e.g.		164500,1,25GT

Type
165000

Type
165050

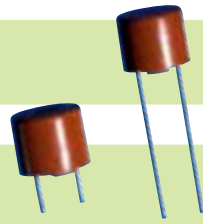

Zeit/Strom-Kennlinien
Time-Current Characteristics

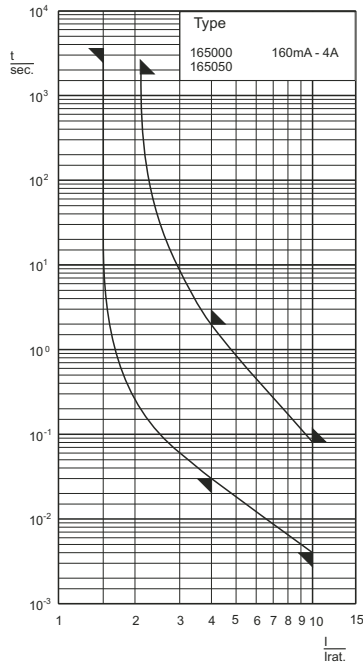

Abmessungen
Dimensions
165000 (x=0 lange Stifte/long pins)

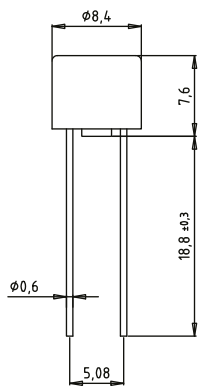

165050 (x=5 kurze Stifte/short pins)

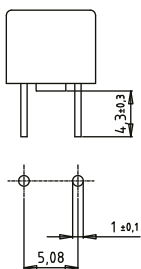

Aufbau / Construction

Gehäuse / body

Thermoplast, braun / thermoplastic, brown
temperaturbeständig / temperature resistant
selbstverlöschend / self-extinguishing

Anschlussstifte / terminations

0,6 mm Ø, verzinkt / tinned
löt- oder steckbar / solder or plug

Zubehör / Related Products

Halter / holder 166602

siehe Seite 74 / see page 74

Schmelzeitgrenzwerte / Fusing time limits

Bemessungsstrom Rated Current	1,5 I _n		2,1 I _n		2,75 I _n		4 I _n		10 I _n	
	min.	max.	min.	max.	min.	max.	min.	max.	min.	max.
160 mA - 4 A	1 h	30 min	-	-	30 ms	2 s	4 ms	80 ms		

(IEC 60127-3)	8,4 x 7,6 mm	250 V	M mittelträge medium time-lag
---------------	---------------------	-------	-------------------------------------

Artikel-Nr. Article-no.	Bemessungsstrom Rated Current	Bemessungs-Ausschaltvermögen Rated Breaking Capacity	Spannungsfall Voltage Drop	Leistungsabgabe Power Dissipation (@1,5 I _n)	Schmelzintegral I ² t ₅ Value	Approbationen Approvals
			mV	mW	A ² s	
1650x0,0,16	160 mA	35 A @ AC 250 V	325	140	0,075	
1650x0,0,2	200 mA	35 A @ AC 250 V	120	80	0,02	
1650x0,0,25	250 mA	35 A @ AC 250 V	120	90	0,036	
1650x0,0,315	315 mA	35 A @ AC 250 V	120	120	0,055	
1650x0,0,4	400 mA	35 A @ AC 250 V	110	140	0,11	
1650x0,0,5	500 mA	35 A @ AC 250 V	100	160	0,2	
1650x0,0,63	630 mA	35 A @ AC 250 V	90	180	0,33	
1650x0,0,8	800 mA	35 A @ AC 250 V	80	140	0,58	
1650x0,1	1 A	35 A @ AC 250 V	70	160	0,9	
1650x0,1,25	1,25 A	35 A @ AC 250 V	65	190	1,4	
1650x0,1,6	1,6 A	35 A @ AC 250 V	65	200	2,5	
1650x0,2	2 A	35 A @ AC 250 V	60	350	3,1	
1650x0,2,5	2,5 A	35 A @ AC 250 V	55	380	5,2	
1650x0,3,15	3,15 A	35 A @ AC 250 V	55	510	9,9	
1650x0,4	4 A	40 A @ AC 250 V	50	550	16	

x = 0 lange Stifte / long pins
x = 5 kurze Stifte / short pins

Type	Abk. / Abbr.	Beschreibung / Description
165000/165050	-	100 Stück / pieces
165000	GT	1.000 Stück gegurtet / 1.000 pieces on tape
165050	IP	2.000 Stück Industrieverpackung / 2.000 pieces industrial packs
z.B./ e.g.	165000,1,25GT	

Type
166000

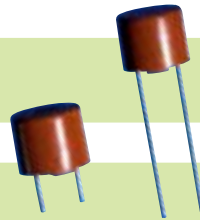

Type
166050



Zeit/Strom-Kennlinien
Time-Current Characteristics

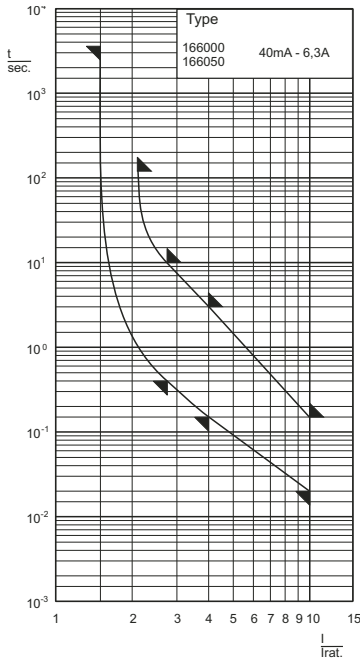

Aufbau / Construction

Gehäuse / body

Thermoplast, braun / thermoplastic, brown
temperaturbeständig / temperature resistant
selbstverlöschend / self-extinguishing

Anschlussstifte / terminations

0,6 mm Ø, verzinkt / tinned
löt- oder steckbar / solder or plug

Zubehör / Related Products

Halter / holder 166602

siehe Seite 74 / see page 74

Schmelzeitgrenzwerte / Fusing time limits

Bemessungsstrom Rated Current	1,5 I _n		2,1 I _n		2,75 I _n		4 I _n		10 I _n	
	min.	max.	min.	max.	min.	max.	min.	max.	min.	max.
40 mA - 6,3 A	1 h	2 min	400 ms	10 s	150 ms	3 s	20 ms	150 ms		

IEC 60127-3/4 EN 60127-3/4 VDE 0820-3/4	8,4 x 7,6 mm	250 V	T träge time-lag
---	---------------------	-------	------------------------

Abmessungen
Dimensions

166000 (x=0 lange Stifte/long pins)

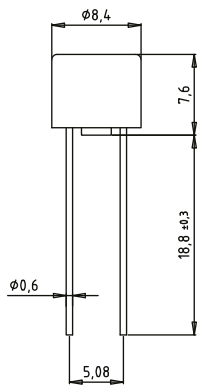

166050 (x=5 kurze Stifte/short pins)

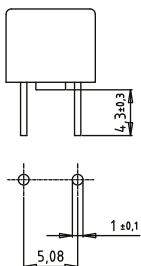

Artikel-Nr. Article-no.	Bemessungs- strom Rated Current	Bemessungs- Ausschaltvermögen Rated Breaking Capacity	Spannungs- fall Voltage Drop	Leistungs- abgabe Power Dissipa- tion (@1,5 I _n)	Schmelz- integral I ² t ₅₀ Value	Approbationen Approvals		
						Semko	VDE	UL rec.
1660x0,04	40 mA	35 A @ AC 250 V	530	60	0,015	✓	✓	✓
1660x0,05	50 mA	35 A @ AC 250 V	490	70	0,017	✓	✓	✓
1660x0,063	63 mA	35 A @ AC 250 V	390	80	0,02	✓	✓	✓
1660x0,08	80 mA	35 A @ AC 250 V	300	90	0,035	✓	✓	✓
1660x0,1	100 mA	35 A @ AC 250 V	260	100	0,06	✓	✓	✓
1660x0,125	125 mA	35 A @ AC 250 V	180	110	0,12	✓	✓	✓
1660x0,16	160 mA	35 A @ AC 250 V	170	130	0,21	✓	✓	✓
1660x0,2	200 mA	35 A @ AC 250 V	160	140	0,32	✓	✓	✓
1660x0,25	250 mA	35 A @ AC 250 V	150	150	0,5	✓	✓	✓
1660x0,315	315 mA	35 A @ AC 250 V	140	160	0,8	✓	✓	✓
1660x0,4	400 mA	35 A @ AC 250 V	130	170	1,1	✓	✓	✓
1660x0,5	500 mA	35 A @ AC 250 V	120	180	1,8	✓	✓	✓
1660x0,63	630 mA	35 A @ AC 250 V	110	200	3,2	✓	✓	✓
1660x0,8	800 mA	35 A @ AC 250 V	100	220	5,2	✓	✓	✓
1660x0,1	1 A	35 A @ AC 250 V	85	240	8	✓	✓	✓
1660x0,1,25	1,25 A	35 A @ AC 250 V	75	290	12	✓	✓	✓
1660x0,1,6	1,6 A	35 A @ AC 250 V	70	350	22	✓	✓	✓
1660x0,2	2 A	35 A @ AC 250 V	70	480	30	✓	✓	✓
1660x0,2,5	2,5 A	35 A @ AC 250 V	70	520	46	✓	✓	✓
1660x0,3,15	3,15 A	35 A @ AC 250 V	70	600	80	✓	✓	✓
1660x0,4	4 A	40 A @ AC 250 V	70	800	130	✓	✓	✓
1660x0,5	5 A ¹⁾	50 A @ AC 250 V	70	1000	130	✓	✓	✓
1660x0,6,3	6,3 A ¹⁾	63 A @ AC 250 V	70	1200	230	✓	✓	

x = 0 lange Stifte / long pins

x = 5 kurze Stifte / short pins

¹⁾ Zusätzlich lieferbare Bemessungsströme / Non-standard ratings also available

Type	Abk. Abbr.	Beschreibung Description
160000/166050	-	100 Stück / pieces
166000	GT	1.000 Stück gegurtet / 1.000 pieces on tape
166050	IP	2.000 Stück Industrieverpackung / 2.000 pieces industrial packs
z.B./ e.g.		166000,0,315GT

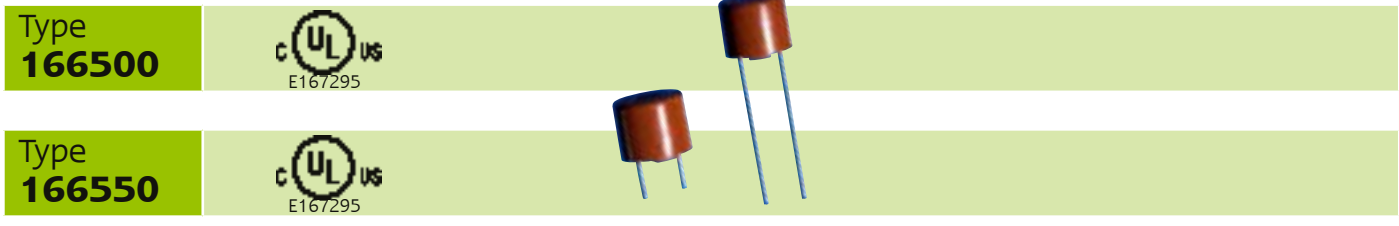

Type
166500



Type
166550



Zeit/Strom-Kennlinien
Time-Current Characteristics

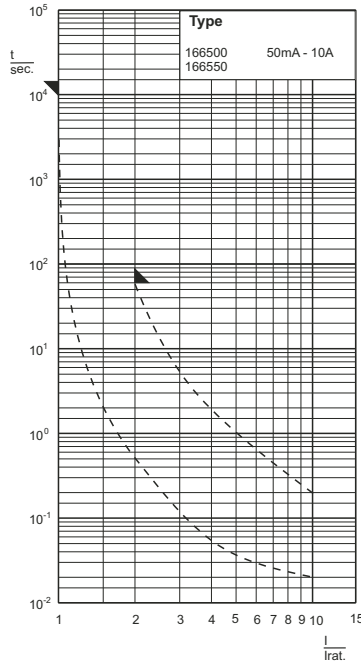

Aufbau / Construction

Gehäuse / body Thermoplast, braun / thermoplastic, brown
 temperaturbeständig / temperature resistant
 selbstverlöschend / self-extinguishing

Schmelzleiter gedruckt / printed fuse-element

Anschlussstifte / terminations 0,6 mm Ø, verzinkt / tinned
 löt- oder steckbar / solder or plug

Zubehör / Related Products

Halter / holder 166602 siehe Seite 74 / see page 74

Schmelzeitgrenzwerte / Fusing time limits

Bemessungsstrom Rated Current	100% I _n		135% I _n		150% I _n		200% I _n	
	min.	max.	min.	max.	min.	max.	min.	max.
50 mA - 10 A	4 h	-	-	-	-	-	-	60 s

UL 248-14 CSA C22.2 No. 248.14	8,4 x 7,6 mm	250 V	T träge time-lag
-----------------------------------	---------------------	-------	------------------------

Abmessungen
Dimensions

166500 (x=0 lange Stifte/long pins)

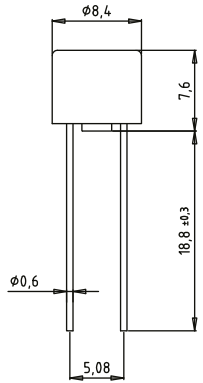

166550 (x=5 kurze Stifte/short pins)

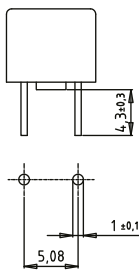

Artikel-Nr. Article-no.	Bemessungs- strom Rated Current	Bemessungs- Ausschaltvermögen Rated Breaking Capacity	Spannungsfall Voltage Drop	Leistungsabgabe Power Dissipa- tion (@1,0 I _n)	Schmelz- integral I ² t ₉₀ Value	Approbationen Approvals	
			mV	mW	A ² s	UL	cUL
1665x0,05	50 mA	50 A @ AC 250 V	800	40	0,015	✓	✓
1665x0,063	63 mA	50 A @ AC 250 V	700	45	0,017	✓	✓
1665x0,08	80 mA	50 A @ AC 250 V	600	50	0,02	✓	✓
1665x0,01	100 mA	50 A @ AC 250 V	500	50	0,025	✓	✓
1665x0,0125	125 mA	50 A @ AC 250 V	400	50	0,03	✓	✓
1665x0,016	160 mA	50 A @ AC 250 V	350	55	0,07	✓	✓
1665x0,02	200 mA	50 A @ AC 250 V	300	60	0,14	✓	✓
1665x0,025	250 mA	50 A @ AC 250 V	250	65	0,25	✓	✓
1665x0,0315	315 mA	50 A @ AC 250 V	240	75	0,42	✓	✓
1665x0,04	400 mA	50 A @ AC 250 V	230	95	0,53	✓	✓
1665x0,05	500 mA	50 A @ AC 250 V	220	110	1,0	✓	✓
1665x0,063	630 mA	50 A @ AC 250 V	170	110	1,5	✓	✓
1665x0,08	800 mA	50 A @ AC 250 V	150	120	3,1	✓	✓
1665x0,1	1 A	50 A @ AC 250 V	130	130	4,8	✓	✓
1665x0,125	1,25 A	50 A @ AC 250 V	150	190	5,7	✓	✓
1665x0,16	1,6 A	50 A @ AC 250 V	145	235	11	✓	✓
1665x0,2	2 A	50 A @ AC 250 V	125	250	18	✓	✓
1665x0,25	2,5 A	50 A @ AC 250 V	120	300	25	✓	✓
1665x0,315	3,15 A	50 A @ AC 250 V	110	350	40	✓	✓
1665x0,4	4 A	50 A @ AC 250 V	100	400	72	✓	✓
1665x0,5	5 A	50 A @ AC 250 V	95	475	130	✓	✓
1665x0,63	6,3 A	50 A @ AC 250 V	90	570	130	✓	✓
1665x0,8	8 A	50 A @ AC 250 V	90	720	230		
1665x0,10	10 A	50 A @ AC 250 V	90	900	370		

x = 0 lange Stifte / long pins
x = 5 kurze Stifte / short pins

Type	Abk. Abbr.	Beschreibung Description
166500/166550	-	100 Stück / pieces
166500	GT	1.000 Stück gegurtet / 1.000 pieces on tap
166550	IP	2.000 Stück Industrieverpackung / 2.000 pieces industrial packs
z.B./ e.g.	166500,3,15GT	

G-Sicherungseinsätze / Miniature Fuse-Links

Keramikrohr / Ceramic tube
Glasrohr/ Glass tube
Ohne und mit Kennmelder / Without
or with indicator

Type
7000140

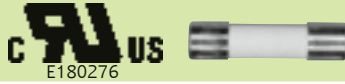

Zeit/Strom-Kennlinien
Time-Current Characteristics

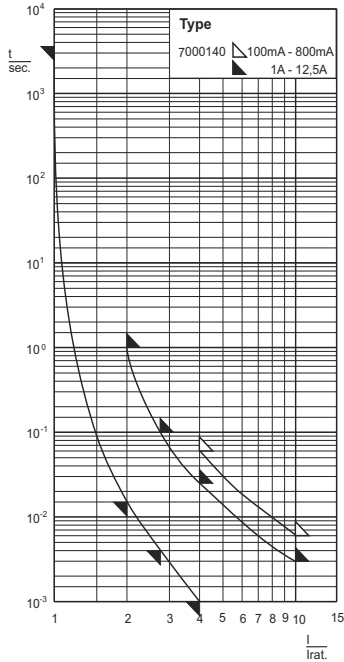

Abmessungen
Dimensions

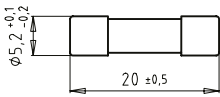

Aufbau / Construction
Keramikrohr / ceramic tube

undurchsichtig / non-transparent
mit Löschmittelfüllung / with filling

Kontaktkappen / end caps

Messing vernickelt / brass, nickel-plated

Schmelzeitgrenzwerte / Fusing time limits

Bemessungsstrom Rated Current	1 I _n		2 I _n		2,75 I _n		4 I _n		10 I _n	
	min.	max.	min.	max.	min.	max.	min.	max.	min.	max.
100 mA - 800 mA	1 h	-	-	-	-	-	60 ms	-	-	6 ms
1 A - 12,5 A	1 h	1 s	4 ms	100 ms	1 ms	25 ms	-	-	-	3 ms

Sondertyp Special type	5 x 20 mm	250 V	FF superflink very quick acting
---------------------------	------------------	-------	---------------------------------------

Artikel-Nr. Article-no.	Bemessungsstrom Rated Current	Bemessungs-Ausschaltvermögen Rated Breaking Capacity	Spannungsfall Voltage Drop	Leistungsabgabe Power Dissipation (@1,0 I _n)	Schmelzintegral I ² t ₅ Value	Approbationen Approvals
			mV	W	A ² s	UL rec.
7000140.0,1	100 mA	200 kA @ AC 250 V	1000	0,1	0,0016	
7000140.0,125	125 mA	200 kA @ AC 250 V	950	0,12	0,0024	✓
7000140.0,16	160 mA	200 kA @ AC 250 V	1300	0,3	0,004	✓
7000140.0,2	200 mA	200 kA @ AC 250 V	600	0,2	0,01	✓
7000140.0,25	250 mA	200 kA @ AC 250 V	550	0,2	0,02	✓
7000140.0,315	315 mA	200 kA @ AC 250 V	500	0,2	0,04	✓
7000140.0,4	400 mA	200 kA @ AC 250 V	500	0,2	0,07	✓
7000140.0,5	500 mA	200 kA @ AC 250 V	550	0,3	0,07	✓
7000140.0,63	630 mA	200 kA @ AC 250 V	600	0,4	0,15	✓
7000140.0,8	800 mA	200 kA @ AC 250 V	600	0,5	0,32	✓
7000140.1	1 A	200 kA @ AC 250 V	600	0,6	0,32	✓
7000140.1,25	1,25 A	200 kA @ AC 250 V	400	0,5	0,20	✓
7000140.1,6	1,6 A	200 kA @ AC 250 V	400	0,7	0,31	✓
7000140.2	2 A	200 kA @ AC 250 V	400	0,8	0,64	✓
7000140.2,5	2,5 A	200 kA @ AC 250 V	400	1,0	0,88	✓
7000140.3,15	3,15 A	200 kA @ AC 250 V	400	1,3	1,6	✓
7000140.4	4 A	200 kA @ AC 250 V	350	1,4	3,2	✓
7000140.5	5 A	200 kA @ AC 250 V	350	1,8	5,9	✓
7000140.6,3	6,3 A	1500 A @ AC 250 V	300	1,9	10	
7000140.8	8 A	1500 A @ AC 250 V	300	2,4	19	
7000140.10	10 A	1500 A @ AC 250 V	300	3,0	30	
7000140.12,5	12,5 A	1500 A @ AC 250 V	200	2,5	115	

Bei Verwendung dieser G-Sicherungseinsätze ab 6,3 A ist auf ausreichende Wärmeabfuhr zu achten.
When using this type from 6.3 A up, consideration should be given to heat

Type	Abk. Abbr.	Beschreibung Description
7000140	-	100 Stück / pieces (10 x 10)
	IP	1.000 Stück Industrieverpackung / 1.000 pieces industrial packs
z.B./ e.g.	7000140.3,15IP	

Type
7000740

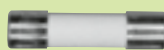

Zeit/Strom-Kennlinien
Time-Current Characteristics

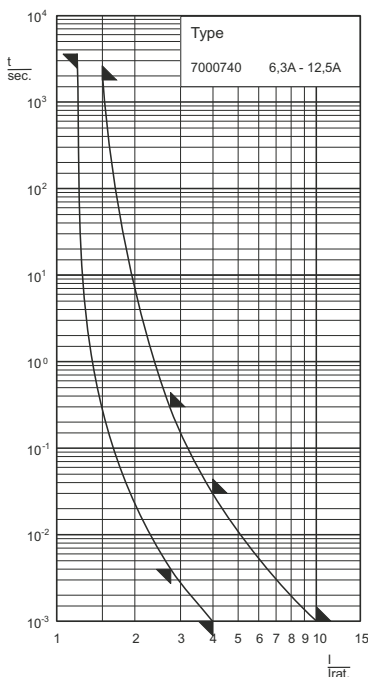
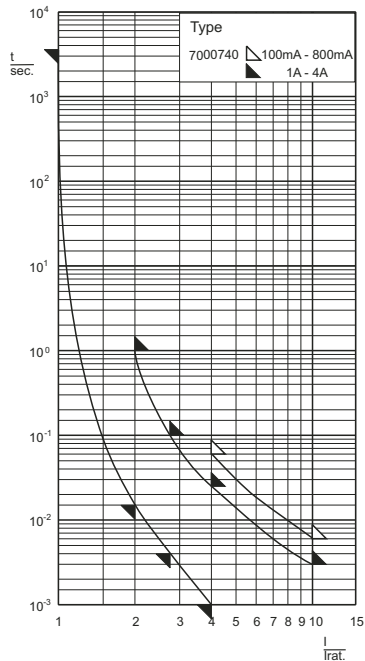

Abmessungen
Dimensions

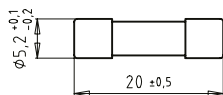

Aufbau / Construction

Keramikrohr / ceramic tube

undurchsichtig / non-transparent
mit Löschmittelfüllung / with filling

Kontaktkappen / end caps

Messing vernickelt / brass, nickel-plated

Schmelzeitgrenzwerte / Fusing time limits

Bemessungsstrom Rated Current	1 I _n		2 I _n		2,75 I _n		4 I _n		10 I _n	
	min.	max.	min.	max.	min.	max.	min.	max.	min.	max.
100 mA - 800 mA	1 h	-	-	-	-	-	60 ms	-	-	6 ms
1 A - 4 A	1 h	1 s	4 ms	100 ms	1 ms	25 ms	-	-	-	3 ms

Bemessungsstrom Rated Current	1,2 I _n		1,5 I _n		2,75 I _n		4 I _n		10 I _n	
	min.	max.	min.	max.	min.	max.	min.	max.	min.	max.
6,3 A - 12,5 A	1 h	30 min.	4 ms	300 ms	1 ms	30 ms	-	-	-	1 ms

Sondertyp Special type	5 x 20 mm	400 V	FF superflink very quick acting
---------------------------	------------------	-------	---------------------------------------

Artikel-Nr. Article-no.	Bemessungsstrom Rated Current	Bemessungs-Ausschaltvermögen Rated Breaking Capacity	Spannungsfall Voltage Drop	Leistungsabgabe Power Dissipation (@1,0 I _n)	Schmelz-integral I ² t _s Value	Approbationen Approvals
			mV	W	A ² s	
7000740.0,1	100 mA	10 kA @ AC 400 V	4000	0,4	0,0016	
7000740.0,125	125 mA	10 kA @ AC 400 V	3500	0,5	0,0024	
7000740.0,16	160 mA	10 kA @ AC 400 V	1300	0,3	0,004	
7000740.0,2	200 mA	10 kA @ AC 400 V	600	0,2	0,01	
7000740.0,25	250 mA	10 kA @ AC 400 V	550	0,2	0,02	
7000740.0,315	315 mA	10 kA @ AC 400 V	500	0,2	0,04	
7000740.0,4	400 mA	10 kA @ AC 400 V	500	0,2	0,07	
7000740.0,5	500 mA	10 kA @ AC 400 V	550	0,3	0,07	
7000740.0,63	630 mA	10 kA @ AC 400 V	600	0,4	0,15	
7000740.0,8	800 mA	10 kA @ AC 400 V	600	0,5	0,32	
7000740.1	1 A	10 kA @ AC 400 V	600	0,6	0,32	
7000740.1,25	1,25 A	10 kA @ AC 400 V	400	0,5	0,2	
7000740.1,6	1,6 A	10 kA @ AC 400 V	400	0,7	0,31	
7000740.2	2 A	10 kA @ AC 400 V	400	0,8	0,64	
7000740.2,5	2,5 A	10 kA @ AC 400 V	400	1,0	0,88	
7000740.3,15	3,15 A	10 kA @ AC 400 V	400	1,3	1,6	
7000740.4	4 A	10 kA @ AC 400 V	350	1,4	3,2	

cosφ = 0,7

Artikel-Nr. Article-no.	Bemessungsstrom Rated Current	Bemessungs-Ausschaltvermögen Rated Breaking Capacity	Spannungsfall Voltage Drop	Leistungsabgabe Power dissipation (@1,5 I _n)	Schmelz-integral I ² t _s Value	Approbationen Approvals
			mV	W	A ² s	UL rec.
7000740.6,3	6,3 A	200 kA @ AC 250 V ¹⁾	250	2,8	1,6	✓
7000740.8	8 A	200 kA @ AC 250 V ¹⁾	230	3,0	4,5	✓
7000740.10	10 A	200 kA @ AC 250 V ¹⁾	180	3,4	8,8	✓
7000740.12,5	12,5 A	200 kA @ AC 250 V ¹⁾	150	4,0	15	✓
7000740.16	16 A	10 kA @ AC 125 V	130	3,8	46	

¹⁾ cosφ < 0,2

Bei Verwendung dieser G-Sicherungseinsätze ab 6,3 A ist auf ausreichende Wärmeabfuhr zu achten.
When using this type from 6.3 A up, consideration should be given to heat

Type	Abk. Abbr.	Beschreibung Description
7000740	-	100 Stück / pieces (10 x 10)
	IP	1.000 Stück Industrieverpackung / 1.000 pieces industrial packs
z.B./ e.g.	7000740.1,25IP	

Type
7018040



Zeit/Strom-Kennlinien
Time-Current Characteristics

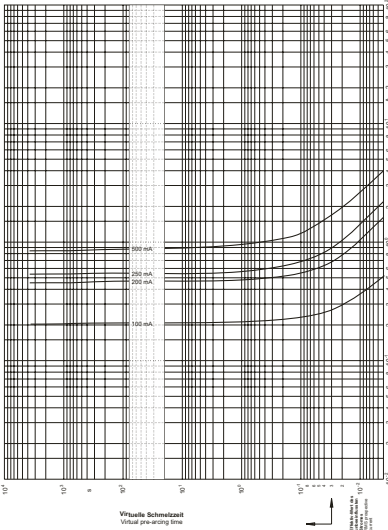

Aufbau / Construction

Keramikrohr / ceramic tube

undurchsichtig / non-transparent
mit Löschmittelfüllung / with filling

Kontaktkappen / end caps

Messing vernickelt / brass, nickel-plated

Schmelzeitgrenzwerte / Fusing time limits

Bemessungsstrom Rated Current	1 I _n		2 I _n		2,75 I _n		4 I _n		10 I _n	
	min.	max.	min.	max.	min.	max.	min.	max.	min.	max.
100 mA - 500 mA	1 h	-	-	-	-	-	-	60 ms	-	6 ms

nur für Kurzschlusschutz for short circuit protection only	5 x 20 mm	660 V	aR (FF)
---	------------------	-------	---------

Artikel-Nr. Article-no.	Bemessungsstrom Rated Current	Bemessungs-Ausschaltvermögen Rated Breaking Capacity	Spannungsfall Voltage Drop	Leistungsabgabe Power Dissipation (@1,0 I _n)	Schmelzintegral I ² t _s Value	Approbationen Approvals
7018040.0,1	100 mA	100 kA @ AC/DC 660 V	1000 mV	0,1 W	0,0009 A ² s	.
7018040.0,2	200 mA	100 kA @ AC/DC 660 V	600 mV	0,2 W	0,01 A ² s	
7018040.0,25	250 mA	100 kA @ AC/DC 660 V	550 mV	0,2 W	0,02 A ² s	
7018040.0,5	500 mA	100 kA @ AC/DC 660 V	550 mV	0,3 W	0,07 A ² s	

Abmessungen
Dimensions

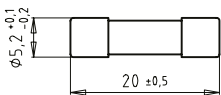

Type	Abk. Abbr.	Beschreibung Description
	-	100 Stück / pieces (10 x 10)

Type
7017640

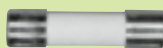

Neu / New

Zeit/Strom-Kennlinien
Time-Current Characteristics

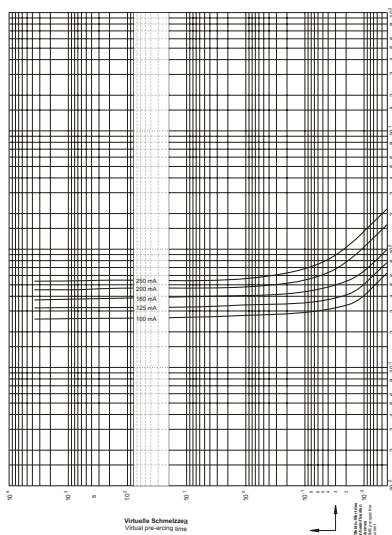

Aufbau / Construction

Keramikrohr / ceramic tube

undurchsichtig / non-transparent
mit Löschmittelfüllung / with filling

Kontaktkappen / end caps

Messing vernickelt / brass, nickel-plated

Schmelzeitgrenzwerte / Fusing time limits

Bemessungsstrom Rated Current	1 I _n		2 I _n		2,75 I _n		4 I _n		10 I _n	
	min.	max.	min.	max.	min.	max.	min.	max.	min.	max.
100 mA - 250 mA	1 h	-	-	-	-	-	60 ms	-	-	6 ms

nur für Kurzschlusschutz for short circuit protection only	5 x 20 mm	1000 V	aR (FF)
---	------------------	--------	---------

Artikel-Nr. Article-no.	Bemessungsstrom Rated Current	Bemessungs-Ausschaltvermögen Rated Breaking Capacity	Spannungsfall Voltage Drop	Leistungsabgabe Power Dissipation (@1,0 I _n)	Schmelzintegral I ² t ₅₀ Value	Approbationen Approvals
7017640.0,1	100 mA	100 kA @ AC 1000 V	4000 mV	0,4 W	0,0016 A ² s	
7017640.0,125	125 mA	100 kA @ AC 1000 V	3500 mV	0,5 W	0,0024 A ² s	
7017640.0,16	160 mA	100 kA @ AC 1000 V	1300 mV	0,3 W	0,004 A ² s	
7017640.0,2	200 mA	100 kA @ AC 1000 V	600 mV	0,2 W	0,01 A ² s	
7017640.0,25	250 mA	100 kA @ AC 1000 V	550 mV	0,2 W	0,02 A ² s	

Abmessungen
Dimensions

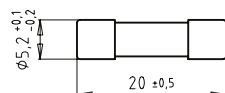

Type	Abk. Abbr.	Beschreibung Description
		- 100 Stück / pieces (10 x 10)

Type
179020



Zeit/Strom-Kennlinien
Time-Current Characteristics

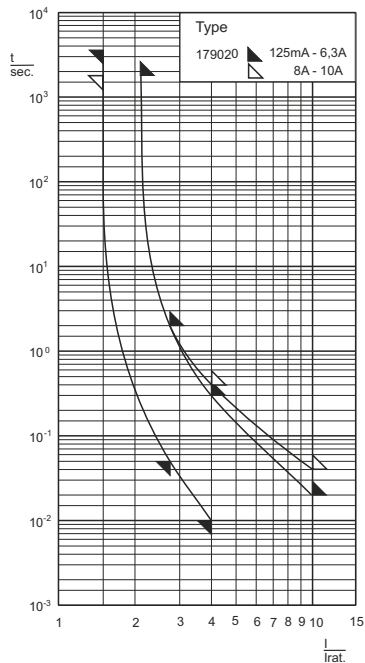
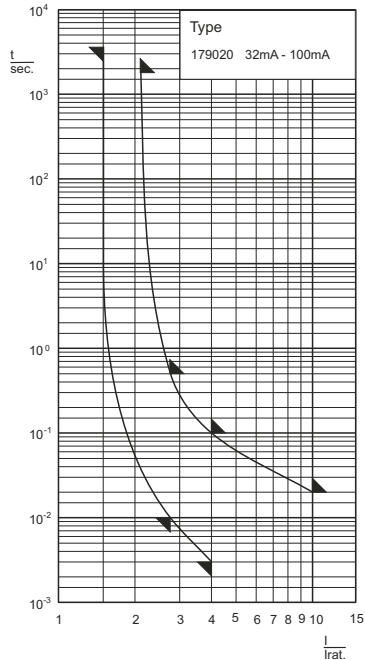

Abmessungen
Dimensions

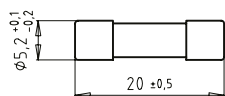

Aufbau / Construction

Glasrohr / glass tube

durchsichtig / transparent

Kontaktkappen / end caps

Messing, vernickelt / brass, nickel-plated

Schmelzeitgrenzwerte / Fusing time limits

Bemessungsstrom Rated Current	1,5 I _n		2,1 I _n		2,75 I _n		4 I _n		10 I _n	
	min.	max.	min.	max.	min.	max.	min.	max.	min.	max.
50 - 100 mA	1 h	30 min	10 ms	500 ms	3 ms	100 ms	-	-	-	20 ms
125 mA - 6,3 A	1h	30 min	50 ms	2 s	10 ms	300 ms	-	-	-	20 ms
8 - 10 A	30 min	30 min	50 ms	2 s	10 ms	400 ms	-	-	-	40 ms

IEC 60127-2/2 EN 60127-2/2 VDE 0820-2/2	5 x 20 mm	250 V	F flink quick acting
---	------------------	-------	----------------------------

Artikel-Nr. Article-no.	Bemessungsstrom Rated Current	Bemessungs-Ausschaltvermögen Rated Breaking Capacity	Spannungsfall Voltage Drop	Leistungsabgabe Power Dissipation (@1,5 I _n)	Schmelzintegral I ² t ₅ Value	Approbationen Approvals			
						Semko	VDE	BEAB	ULrec
179020.0,05	50 mA	35 A @ AC 250 V	3500	0,4	0,0004	✓	✓		✓
179020.0,063	63 mA	35 A @ AC 250 V	3500	0,5	0,0007	✓	✓	✓	✓
179020.0,08	80 mA	35 A @ AC 250 V	2500	0,5	0,0017	✓	✓	✓	✓
179020.0,1	100 mA	35 A @ AC 250 V	2200	0,6	0,0022	✓	✓	✓	✓
179020.0,125	125 mA	35 A @ AC 250 V	350	0,2	0,01	✓	✓	✓	✓
179020.0,16	160 mA	35 A @ AC 250 V	310	0,2	0,02	✓	✓	✓	✓
179020.0,2	200 mA	35 A @ AC 250 V	290	0,2	0,037	✓	✓	✓	✓
179020.0,25	250 mA	35 A @ AC 250 V	280	0,3	0,073	✓	✓	✓	✓
179020.0,315	315 mA	35 A @ AC 250 V	230	0,3	0,16	✓	✓	✓	✓
179020.0,4	400 mA	35 A @ AC 250 V	200	0,3	0,31	✓	✓	✓	✓
179020.0,5	500 mA	35 A @ AC 250 V	160	0,3	0,16	✓	✓	✓	✓
179020.0,63	630 mA	35 A @ AC 250 V	140	0,3	0,39	✓	✓	✓	✓
179020.0,7	700 ¹⁾ mA	35 A @ AC 250 V	140	0,4	0,56				✓
179020.0,8	800 mA	35 A @ AC 250 V	130	0,4	0,8	✓	✓	✓	✓
179020.1	1 A	35 A @ AC 250 V	130	0,5	1,5	✓	✓	✓	✓
179020.1,25	1,25 A	35 A @ AC 250 V	120	0,6	2,0	✓	✓	✓	✓
179020.1,4	1,4 A ¹⁾	35 A @ AC 250 V	120	0,6	2,5				✓
179020.1,5	1,5 A ¹⁾	35 A @ AC 250 V	120	0,7	3,2				✓
179020.1,6	1,6 A	35 A @ AC 250 V	120	0,7	4,1	✓	✓	✓	✓
179020.2	2 A	35 A @ AC 250 V	120	0,9	6,2	✓	✓	✓	✓
179020.2,5	2,5 A	35 A @ AC 250 V	120	1,0	11	✓	✓	✓	✓
179020.3,15	3,15 A	35 A @ AC 250 V	120	1,2	20	✓	✓	✓	✓
179020.3,5	3,5 A ¹⁾	35 A @ AC 250 V	110	1,3	20				
179020.4	4 A	40 A @ AC 250 V	100	1,4	25	✓	✓	✓	✓
179020.5	5 A	50 A @ AC 250 V	100	1,7	42	✓	✓	✓	✓
179020.6,3	6,3 A	63 A @ AC 250 V	100	2,0	79	✓	✓	✓	✓
179020.8	8 A	80 A @ AC 250 V	100	2,2	125				
179020.10	10 A	100 A @ AC 250 V	100	2,4	220				

¹⁾ zusätzlich lieferbare Bemessungsströme / Non-standard ratings also available

Type	Abk. Abbr.	Beschreibung Description
179020	-	100 Stück / Pieces (10 x 10)
	IP	1.000 Stück Industrieverpackung / 1.000 pieces industrial packs
	FC	1.000 Stück mit Farbcode / 1.000 pieces with colour code
	AK	mit montierten Aufsteckkappen/ with assembled push-on caps
z.B./ e.g.		179020.3,15IP

Type 179021



Zeit/Strom-Kennlinien
Time-Current Characteristics

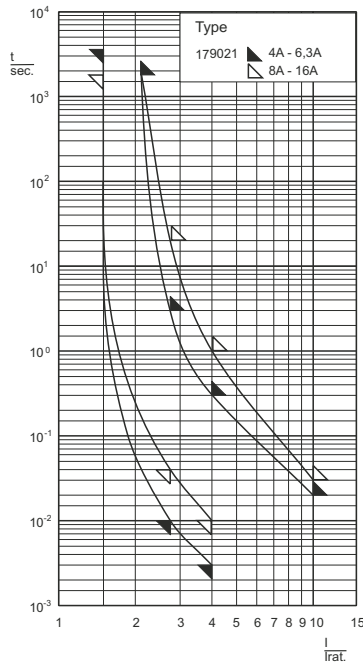
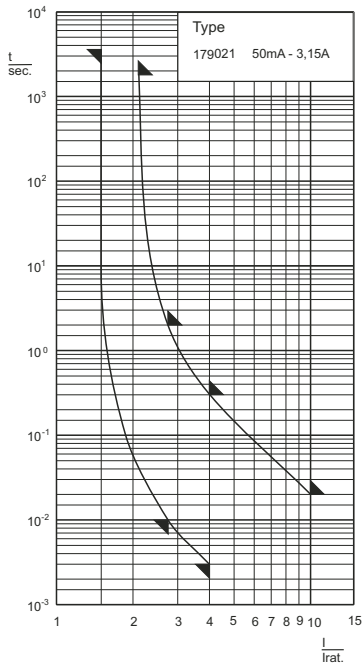

Abmessungen
Dimensions

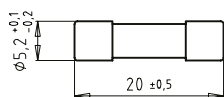

Aufbau / Construction
Keramicrohr / ceramic tube

undurchsichtig / non transparent
ab/from 250mA mit Löschmittelfüllung / with filling
Messing, vernickelt / brass, nickel-plated

Kontaktkappen / end caps

Schmelzeitgrenzwerte / Fusing time limits

Bemessungsstrom Rated Current	1,5 I _n		2,1 I _n		2,75 I _n		4 I _n		10 I _n	
	min.	max.	min.	max.	min.	max.	min.	max.	min.	max.
50 mA - 3,15 A	1 h	30 min	10 ms	2 s	3 ms	300 ms	-	-	-	20 ms
4 - 6,3 A	1 h	30 min	10 ms	3 s	3 ms	300 ms	-	-	-	20 ms
8 - 16 A	30 min	30 min	40 ms	20 s	10 ms	1 s	-	-	-	30 ms

IEC 60127-2/1 EN 60127-2/1 VDE 0820-2/1	5 x 20 mm	250 V	F flink quick acting
---	------------------	-------	----------------------------

Artikel-Nr. Article-no.	Bemessungsstrom Rated Current	Bemessungs-Ausschaltvermögen Rated Breaking Capacity	Spannungsfall Voltage Drop	Leistungsabgabe Power Dissipation (@1,5 I _n)	Schmelzintegral I ² t ₅₀ Value	Approbationen Approvals
			mV	W	A ² s	Semko UL rec.
179021.0,05	50 mA	1500 A @ AC 250 V ¹⁾	4000	0,5	0,00022	✓
179021.0,063	63 mA	1500 A @ AC 250 V ¹⁾	3900	0,6	0,00037	✓
179021.0,08	80 mA	1500 A @ AC 250 V ¹⁾	3200	0,7	0,00073	✓
179021.0,1	100 mA	1500 A @ AC 250 V ¹⁾	2600	0,8	0,0011	✓
179021.0,125	125 mA	1500 A @ AC 250 V ¹⁾	360	0,2	0,01	✓
179021.0,16	160 mA	1500 A @ AC 250 V ¹⁾	320	0,2	0,02	✓
179021.0,2	200 mA	1500 A @ AC 250 V ¹⁾	290	0,2	0,04	✓ ✓
179021.0,25	250 mA	1500 A @ AC 250 V ¹⁾	280	0,3	0,07	✓ ✓
179021.0,315	315 mA	1500 A @ AC 250 V ¹⁾	230	0,3	0,17	✓ ✓
179021.0,4	400 mA	1500 A @ AC 250 V ¹⁾	650	0,9	0,07	✓ ✓
179021.0,5	500 mA	1500 A @ AC 250 V ¹⁾	600	1,0	0,23	✓ ✓
179021.0,63	630 mA	1500 A @ AC 250 V ¹⁾	550	1,1	0,31	✓ ✓
179021.0,8	800 mA	1500 A @ AC 250 V ¹⁾	500	1,3	0,47	✓ ✓
179021.1	1 A	1500 A @ AC 250 V ¹⁾	450	1,4	0,25	✓ ✓
179021.1,25	1,25 A	1500 A @ AC 250 V ¹⁾	400	1,6	0,39	✓ ✓
179021.1,6	1,6 A	1500 A @ AC 250 V ¹⁾	350	1,8	0,45	✓ ✓
179021.2	2 A	1500 A @ AC 250 V ¹⁾	320	2,0	0,88	✓ ✓
179021.2,5	2,5 A	1500 A @ AC 250 V ¹⁾	270	2,1	1,2	✓ ✓
179021.3,15	3,15 A	1500 A @ AC 250 V ¹⁾	220	2,2	4,0	✓ ✓
179021.4	4 A	1500 A @ AC 250 V ¹⁾	180	2,3	10	✓ ✓
179021.5	5 A	1500 A @ AC 250 V ¹⁾	150	2,4	19	✓ ✓
179021.6,3	6,3 A	1500 A @ AC 250 V ¹⁾	130	2,6	32	✓ ✓
179021.8	8 A	1500 A @ AC 250 V ¹⁾	100	2,8	120	✓ ✓
179021.10	10 A	1500 A @ AC 250 V ¹⁾	100	3,0	190	✓ ✓
179021.12,5	12,5 A ²⁾	1000 A @ AC 250 V	100	3,4	300	
179021.16	16 A ²⁾	1000 A @ AC 250 V	100	4,0	600	

¹⁾ cosφ = 0,7-0,8

²⁾ zusätzlich lieferbare Bemessungsströme / Non-standard ratings also available)

IEC: 400mA - 4A 1500A @ DC 250V

Type	Abk. Abbr.	Beschreibung Description
179021	-	100 Stück/ Pieces (10 x 10)
	IP	1.000 Stück Industrieverpackung / 1.000 pieces industrial packs
	FC	1.000 Stück mit Farbcode / 1.000 pieces with colour code
	AK	mit montierten Aufsteckkappen/ with assembled push-on caps
z.B./ e.g. 179021.2,5IP		

Type
171100



Zeit/Strom-Kennlinien
Time-Current Characteristics

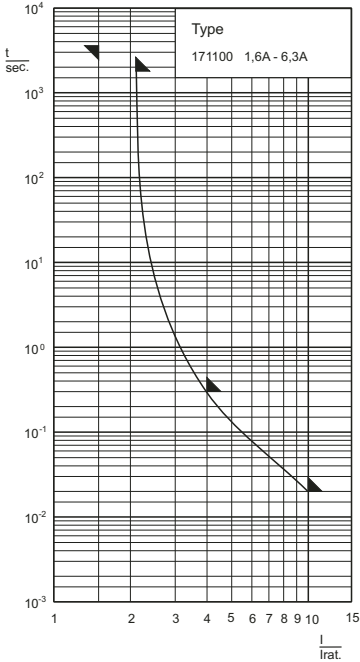

Abmessungen
Dimensions

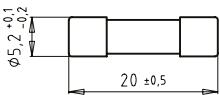

Aufbau / Construction

Glasrohr / glass tube

undurchsichtig / non transparent
mit Löschmittelfüllung / with filling

Kontaktkappen / end caps

Messing, vernickelt / brass, nickel-plated

Schmelzeitgrenzwerte / Fusing time limits

Bemessungsstrom Rated Current	1,5 I _n		2,1 I _n		2,75 I _n		4 I _n		10 I _n	
	min.	max.	min.	max.	min.	max.	min.	max.	min.	max.
1,6 - 6,3 A	1 h	30 min	-	-	-	-	300 ms	-	-	20 ms

(DIN 41571-1)	5 x 20 mm	250 V	F flink quick acting
---------------	------------------	-------	----------------------------

Artikel-Nr. Article-no.	Bemessungsstrom Rated Current	Bemessungs-Ausschaltvermögen Rated Breaking Capacity	Spannungsfall Voltage Drop	Leistungsabgabe Power Dissipation (@1,5 I _n)	Schmelzintegral I ² t ₉₀ Value	Approbationen Approvals
			mV	W	A ² s	
171100.1,6	1,6 A	1000 A @ AC 250 V	480	1,3	1,1	
171100.2	2 A	1000 A @ AC 250 V	400	1,5	2	
171100.2,5	2,5 A	1000 A @ AC 250 V	400	1,6	4	
171100.3,15	3,15 A	1000 A @ AC 250 V	240	1,7	9	
171100.4	4 A	1000 A @ AC 250 V	240	1,9	18	
171100.5	5 A	1000 A @ AC 250 V	230	2,3	32	
171100.6,3	6,3 A	1000 A @ AC 250 V	170	2,8	52	
171100.8	8 A ¹⁾	300 A @ AC 250 V	160	3,2	100	
171100.10	10 A ¹⁾	300 A @ AC 250 V	150	3,4	200	

¹⁾ zusätzlich lieferbare Bemessungsströme / Non-standard ratings also available

Type	Abk. Abbr.	Beschreibung Description
171100	-	100 Stück / Pieces (10 x 10)
	IP	1.000 Stück Industrieverpackung / 1.000 pieces industrial packs
z.B./ e.g.	171100.3,15IP	

Type 172000



Type 172100



Zeit/Strom-Kennlinien
Time-Current Characteristics

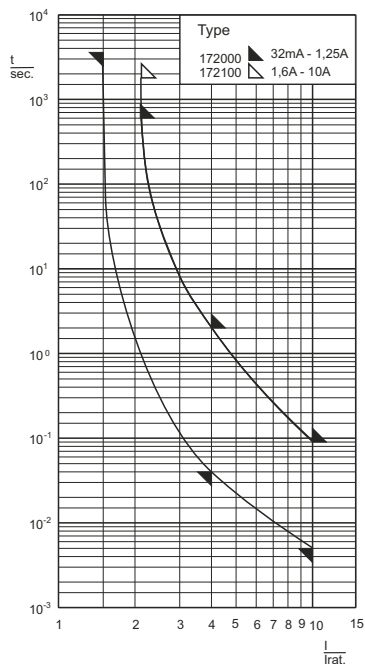

Abmessungen
Dimensions

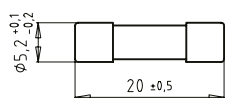

Aufbau / Construction

Glasrohr / glass tube

bis 1,25 A durchsichtig / up to 1,25 A transparent
ab 1,4 A undurchsichtig / from 1,4 A non transparent
mit Löschmittelfüllung / with filling

Kontaktkappen / end caps

Messing, vernickelt / brass, nickel-plated

Schmelzeitgrenzwerte / Fusing time limits

Bemessungsstrom Rated Current	1,5 I _n		2,1 I _n		2,75 I _n		4 I _n		10 I _n	
	min.	max.	min.	max.	min.	max.	min.	max.	min.	max.
32 mA - 1,25 A	1 h	10 min	-	-	40 ms	2 s	5 ms	90 ms		
1,6 - 10 A	1 h	30 min	-	-	40 ms	2 s	5 ms	90 ms		

DIN 41571-2	5 x 20 mm	250 V	M mittelträge medium time-lag
-------------	------------------	-------	-------------------------------------

Artikel-Nr. Article-no.	Bemessungsstrom Rated Current	Bemessungs-Ausschaltvermögen Rated Breaking Capacity	Spannungsfall Voltage Drop	Leistungsabgabe Power Dissipation (@1,5 I _n)	Schmelzintegral I ² t _s Value
			mV	W	A ² s
172000.0,032	32 mA	80 A @ AC 250 V	560	0,1	0,0055
172000.0,04	40 mA	80 A @ AC 250 V	490	0,1	0,008
172000.0,05	50 mA	80 A @ AC 250 V	440	0,1	0,013
172000.0,063	63 mA	80 A @ AC 250 V	330	0,1	0,025
172000.0,08	80 mA	80 A @ AC 250 V	490	0,1	0,040
172000.0,1	100 mA	80 A @ AC 250 V	330	0,1	0,007
172000.0,125	125 mA	80 A @ AC 250 V	230	0,1	0,018
172000.0,16	160 mA	80 A @ AC 250 V	220	0,1	0,036
172000.0,2	200 mA	80 A @ AC 250 V	190	0,2	0,07
172000.0,25	250 mA	80 A @ AC 250 V	150	0,2	0,19
172000.0,315	315 mA	80 A @ AC 250 V	140	0,2	0,35
172000.0,4	400 mA	80 A @ AC 250 V	130	0,2	0,49
172000.0,5	500 mA	80 A @ AC 250 V	120	0,2	0,9
172000.0,63	630 mA	80 A @ AC 250 V	110	0,2	1,4
172000.0,7	700 mA ¹⁾	80 A @ AC 250 V	140	0,3	1,6
172000.0,8	800 mA	80 A @ AC 250 V	100	0,3	3,2
172000.1	1 A	80 A @ AC 250 V	90	0,3	6,5
172000.1,25	1,25 A	80 A @ AC 250 V	80	0,3	5
172100.1,4	1,4 A ¹⁾	1000 A @ AC 250 V	160	0,7	2,8
172100.1,5	1,5 A ¹⁾	1000 A @ AC 250 V	160	0,8	3,0
172100.1,6	1,6 A	1000 A @ AC 250 V	150	0,8	6,1
172100.2	2 A	1000 A @ AC 250 V	130	0,8	5,2
172100.2,5	2,5 A	1000 A @ AC 250 V	110	0,9	10
172100.3,15	3,15 A	1000 A @ AC 250 V	100	1,0	20
172100.4	4 A	1000 A @ AC 250 V	90	1,1	37
172100.5	5 A	1000 A @ AC 250 V	90	1,3	72
172100.6,3	6,3 A	1000 A @ AC 250 V	90	1,6	130
172100.8	8 A	300 A @ AC 250 V	90	2,0	230
172100.10	10 A	300 A @ AC 250 V	90	2,5	370

¹⁾ Zusätzlich lieferbare Bemessungsströme / Non-standard ratings also available

Type	Abk. Abbr.	Beschreibung Description
172000/172100	-	100 Stück / Pieces (10 x 10)
	IP	1.000 Stück Industrieverpackung / 1.000 pieces industrial packs
	z.B./ e.g.	172100.3,15IP

**Type
172200**



**Zeit/Strom-Kennlinien
Time-Current Characteristics**

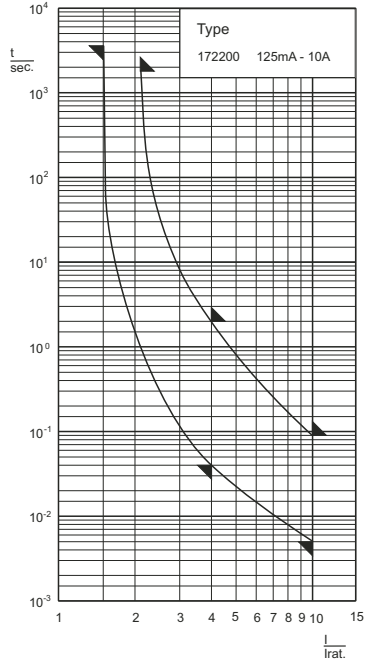

**Abmessungen
Dimensions**

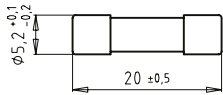

Aufbau / Construction
Keramicrohr / ceramic tube

undurchsichtig / non-transparent
mit Löschmittelfüllung / with filling

Kontaktkappen / end caps

Messing vernickelt / brass, nickel-plated

Schmelzeitgrenzwerte / Fusing time limits

Bemessungsstrom Rated Current	1,5 I _n		2,1 I _n		2,75 I _n		4 I _n		10 I _n	
	min.	max.	min.	max.	min.	max.	min.	max.	min.	max.
125 mA - 10 A	1 h	30 min	-	-	40 ms	2 s	5 ms	90 ms		

(DIN 41571-2)	5 x 20 mm	250 V	M mittelträge medium time-lag
---------------	------------------	-------	-------------------------------------

Artikel-Nr. Article-no.	Bemessungs- strom Rated Current	Bemessungs- Ausschaltvermögen Rated Breaking Capacity	Spannungsfall Voltage Drop	Leistungsabgabe Power Dissipa- tion (@1,5 I _n)	Schmelzintegral I ² t ₅ Value	Approbationen Approvals
			mV	W	A ² s	
172200.0,125	125 mA	1500 A @ AC 250 V	230	0,1	0,018	
172200.0,16	160 mA	1500 A @ AC 250 V	220	0,1	0,036	
172200.0,2	200 mA	1500 A @ AC 250 V	190	0,2	0,07	
172200.0,25	250 mA	1500 A @ AC 250 V	150	0,2	0,19	
172200.0,315	315 mA	1500 A @ AC 250 V	140	0,2	0,35	
172200.0,4	400 mA	1500 A @ AC 250 V	130	0,2	0,49	
172200.0,5	500 mA	1500 A @ AC 250 V	120	0,2	0,9	
172200.0,63	630 mA	1500 A @ AC 250 V	650	0,4	0,6	
172200.0,8	800 mA	1500 A @ AC 250 V	500	0,6	1,0	
172200.1	1 A	1500 A @ AC 250 V	450	0,8	1,5	
172200.1,25	1,25 A	1500 A @ AC 250 V	400	0,8	3,1	
172200.1,6	1,6 A	1500 A @ AC 250 V	150	0,8	6,1	
172200.2	2 A	1500 A @ AC 250 V	130	0,8	5,2	
172200.2,5	2,5 A	1500 A @ AC 250 V	110	0,9	10	
172200.3,15	3,15 A	1500 A @ AC 250 V	100	1,0	20	
172200.4	4 A	1500 A @ AC 250 V	90	1,1	37	
172200.5	5 A	1500 A @ AC 250 V	90	1,3	72	
172200.6,3	6,3 A	1500 A @ AC 250 V	90	1,6	130	
172200.8	8 A	1500 A @ AC 250 V	90	2,0	230	
172200.10	10 A	1500 A @ AC 250 V	90	2,5	370	

Type	Abk. Abbr.	Beschreibung Description
172200	-	100 Stück / Pieces (10 x 10)
	IP	1.000 Stück Industrieverpackung / 1.000 pieces industrial packs
z.B./ e.g.	172200.10IP	

Type
179120



Zeit/Strom-Kennlinien
Time-Current Characteristics

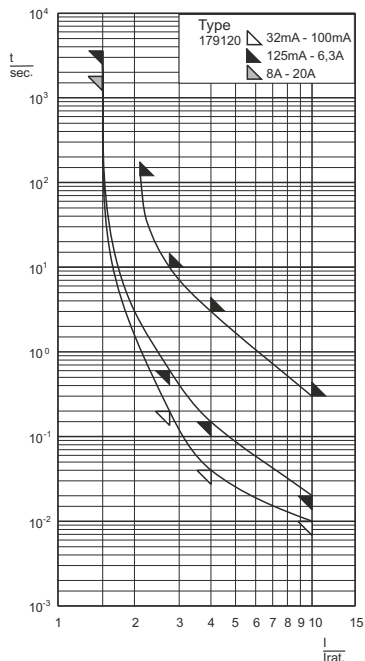

Abmessungen
Dimensions

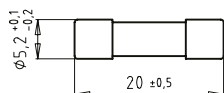

Aufbau / Construction

Glasrohr / glass tube

durchsichtig / transparent

Kontaktkappen / end caps

Messing, vernickelt / brass, nickel-plated

Schmelzeitgrenzwerte / Fusing time limits

Bemessungsstrom Rated Current	1,5 I _n		2,1 I _n		2,75 I _n		4 I _n		10 I _n	
	min.	max.	min.	max.	min.	max.	min.	max.	min.	max.
32 mA - 100 mA	1 h	2 min	200 ms	10 s	40 ms	3 s	10 ms	300 ms		
125 mA - 6,3 A	1 h	2 min	600 ms	10 s	150 ms	3 s	20 ms	300 ms		
8 A - 20 A	30 min	2 min	600 ms	10 s	150 ms	3 s	20 ms	300 ms		

IEC 60127-2/3 EN 60127-2/3 VDE 0820-2/3	5 x 20 mm	250 V	T träge time-lag
---	------------------	-------	------------------------

Artikel-Nr. Article-no.	Bemessungsstrom Rated Current	Bemessungs-Ausschaltvermögen Rated Breaking Capacity	Spannungsfall Voltage Drop	Leistungsabgabe Power Dissipation (@ 1,5 I _n)	Schmelzintegral I ² t ₉₀ Value	Approbationen Approvals		
						Semko	VDE	UL rec.
179120.0,032	32 mA	35 A @ AC 250 V	3000 mV	0,2 W	0,010 A ² s	✓	✓	✓
179120.0,04	40 mA	35 A @ AC 250 V	2000	0,2	0,020	✓	✓	✓
179120.0,05	50 mA	35 A @ AC 250 V	1500	0,2	0,035	✓	✓	✓
179120.0,063	63 mA	35 A @ AC 250 V	1000	0,2	0,05	✓	✓	✓
179120.0,08	80 mA	35 A @ AC 250 V	800	0,2	0,12	✓	✓	✓
179120.0,1	100 mA	35 A @ AC 250 V	700	0,3	0,16	✓	✓	✓
179120.0,125	125 mA	35 A @ AC 250 V	600	0,3	0,24	✓	✓	✓
179120.0,160	160 mA	35 A @ AC 250 V	600	0,3	0,4	✓	✓	✓
179120.0,2	200 mA	35 A @ AC 250 V	500	0,3	0,7	✓	✓	✓
179120.0,25	250 mA	35 A @ AC 250 V	400	0,3	1,4	✓	✓	✓
179120.0,315	315 mA	35 A @ AC 250 V	140	0,2	0,35	✓	✓	✓
179120.0,4	400 mA	35 A @ AC 250 V	130	0,2	0,49	✓	✓	✓
179120.0,5	500 mA	35 A @ AC 250 V	120	0,2	0,9	✓	✓	✓
179120.0,63	630 mA	35 A @ AC 250 V	110	0,2	1,4	✓	✓	✓
179120.0,7	700 mA	35 A @ AC 250 V	140	0,3	1,6			
179120.0,8	800 mA	35 A @ AC 250 V	100	0,3	3,2	✓	✓	✓
179120.1	1 A	35 A @ AC 250 V	90	0,3	6,5	✓	✓	✓
179120.1,25	1,25 A	35 A @ AC 250 V	80	0,3	5,0	✓	✓	✓
179120.1,4	1,4 A	35 A @ AC 250 V	80	0,4	5,2			
179120.1,5	1,5 A	35 A @ AC 250 V	80	0,4	8,5			
179120.1,6	1,6 A	35 A @ AC 250 V	80	0,4	10	✓	✓	✓
179120.2	2 A	35 A @ AC 250 V	80	0,5	20	✓	✓	✓
179120.2,5	2,5 A	35 A @ AC 250 V	80	0,6	26	✓	✓	✓
179120.3,15	3,15 A	35 A @ AC 250 V	80	0,6	44	✓	✓	✓
179120.3,5	3,5 A	35 A @ AC 250 V	80	0,8	50			
179120.4	4 A	40 A @ AC 250 V	80	0,8	72	✓	✓	✓
179120.5	5 A	50 A @ AC 250 V	80	1,2	130	✓	✓	✓
179120.6,3	6,3 A	63 A @ AC 250 V	70	1,3	230	✓	✓	✓
179120.8	8 A	80 A @ AC 250 V	70	1,8	240			
179120.10	10 A	100 A @ AC 250 V	70	2,4	380			
179120.12,5	12,5 A	125 A @ AC 250 V	70	3,0	650			
179120.16	16 A	160 A @ AC 250 V	70	3,2	1300			
179120.20	20 A	200 A @ AC 250 V	70	3,5	2200			

Type	Abk. Abbr.	Beschreibung Description
179120	-	100 Stück / 100 Pieces (10 x 10)
	IP	1.000 Stück Industrieverpackung / 1.000 pieces industrial packs
	FC	1.000 Stück mit Farbcode / 1.000 pieces with colour code
	AK	mit montierten Aufsteckkappen/ with assembled push-on caps
z.B./ e.g.	179120.1,25IP	

**Type
179150**



**Zeit/Strom-Kennlinien
Time-Current Characteristics**

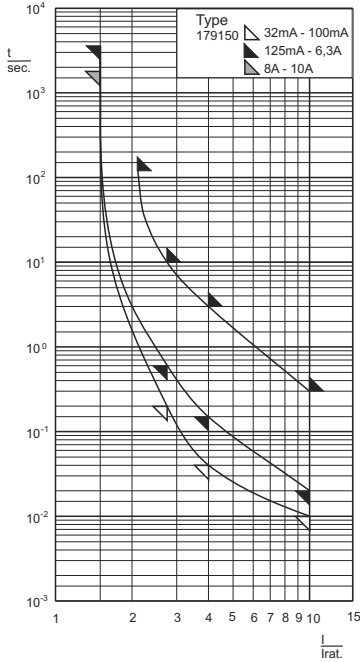

**Abmessungen
Dimensions**

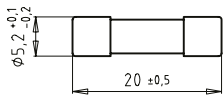

Aufbau / Construction

Glasrohr / glass tube

durchsichtig / transparent

Kontaktkappen / end caps

Messing, vernickelt / brass, nickel-plated

Schmelzeitgrenzwerte / Fusing time limits

Bemessungsstrom Rated Current	1,5 I _n		2,1 I _n		2,75 I _n		4 I _n		10 I _n	
	min.	max.	min.	max.	min.	max.	min.	max.	min.	max.
32 mA - 100 mA	1 h	2 min	200 ms	10 s	40 ms	3 s	10 ms	300 ms		
125 mA - 6,3 A	1 h	2 min	600 ms	10 s	150 ms	3 s	20 ms	300 ms		
8 A - 10 A	30 min	2 min	600 ms	10 s	150 ms	3 s	20 ms	300 ms		

IEC 60127-2/6 EN 60127-2/6 VDE 0820-2/6	5 x 20 mm	250 V	T träge time-lag
---	------------------	-------	------------------------

Artikel-Nr. Article-no.	Bemessungs- strom Rated Current	Bemessungs- Ausschaltvermögen Rated Breaking Capacity	Spannungsfall Voltage Drop	Leistungsabgabe Power Dissipa- tion (@1,5 I _n)	Schmelzintegral I ² t _s Value	Approbationen Approvals
179150.0,032	32 mA	150 A @ AC 250 V	3000 mV	0,2 W	0,010 A ² s	
179150.0,04	40 mA	150 A @ AC 250 V	2000	0,2	0,020	
179150.0,05	50 mA	150 A @ AC 250 V	1500	0,2	0,035	
179150.0,063	63 mA	150 A @ AC 250 V	1000	0,2	0,05	
179150.0,08	80 mA	150 A @ AC 250 V	800	0,2	0,12	
179150.0,1	100 mA	150 A @ AC 250 V	700	0,3	0,16	
179150.0,125	125 mA	150 A @ AC 250 V	600	0,3	0,24	
179150.0,16	160 mA	150 A @ AC 250 V	600	0,3	0,4	
179150.0,2	200 mA	150 A @ AC 250 V	500	0,3	0,7	
179150.0,25	250 mA	150 A @ AC 250 V	400	0,3	1,4	
179150.0,315	315 mA	150 A @ AC 250 V	140	0,2	0,35	
179150.0,4	400 mA	150 A @ AC 250 V	130	0,2	0,49	
179150.0,5	500 mA	150 A @ AC 250 V	120	0,2	0,9	
179150.0,63	630 mA	150 A @ AC 250 V	110	0,2	1,4	
179150.0,8	800 mA	150 A @ AC 250 V	100	0,3	3,2	
179150.1	1 A	150 A @ AC 250 V	90	0,3	6,5	
179150.1,25	1,25 A	150 A @ AC 250 V	80	0,3	5,0	
179150.1,6	1,6 A	150 A @ AC 250 V	80	0,4	10	
179150.2	2 A	150 A @ AC 250 V	80	0,5	20	
179150.2,5	2,5 A	150 A @ AC 250 V	80	0,6	26	
179150.3,15	3,15 A	150 A @ AC 250 V	80	0,6	44	
179150.4	4 A	150 A @ AC 250 V	80	0,8	72	
179150.5	5 A	150 A @ AC 250 V	80	1,2	130	
179150.6,3	6,3 A	150 A @ AC 250 V	70	1,3	230	
179150.8	8 A	150 A @ AC 250 V	70	1,8	240	
179150.10	10 A	150 A @ AC 250 V	70	2,4	380	

Type	Abk. Abbr.	Beschreibung Description
179150	-	100 Stück / Pieces (10 x 10)
	IP	1.000 Stück Industrieverpackung / 1.000 pieces industrial packs
z.B./ e.g.	179150.0,63IP	

Type
179200

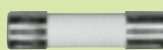

Zeit/Strom-Kennlinien
Time-Current Characteristics

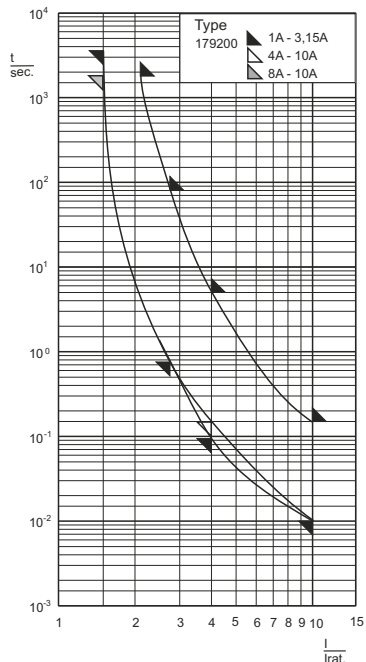
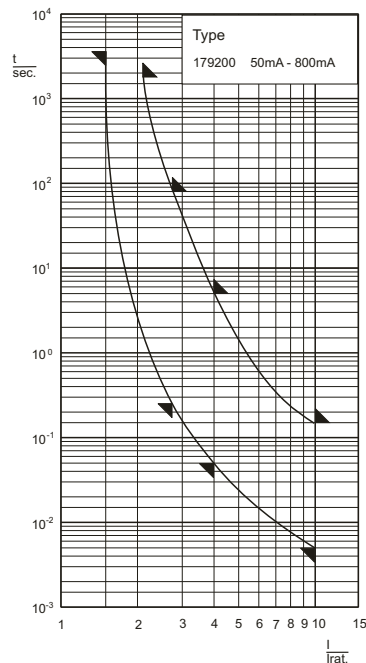

Abmessungen
Dimensions

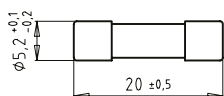

Aufbau / Construction
Keramikrohr / ceramic tube

undurchsichtig / non transparent
ab/from 80mA mit Löschmittelfüllung/with filling

Kontaktkappen / end caps

Messing, vernickelt / brass, nickel-plated

Schmelzeitgrenzwerte / Fusing time limits

Bemessungsstrom Rated Current	1,5 I _n		2,1 I _n		2,75 I _n		4 I _n		10 I _n	
	min.	max.	min.	max.	min.	max.	min.	max.	min.	max.
50 mA - 800 mA	1 h	30 min	250 ms	80 s	50 ms	5 s	5 ms	150 ms		
1 A - 3,15 A	1 h	30 min	750 ms	80 s	95 ms	5 s	10 ms	150 ms		
4 A - 6,3 A	1 h	30 min	750 ms	80 s	150 ms	5 s	10 ms	150 ms		
8 A - 16 A	30 min	30 min	750 ms	80 s	150 ms	5 s	10 ms	150 ms		

IEC 60127-2/5 EN 60127-2/5 VDE 0820-2/5	5 x 20 mm	250V	T träge time-lag
---	------------------	------	------------------------

Artikel-Nr. Article-no.	Bemessungs- strom Rated Current	Bemessungs- Ausschaltvermögen Rated Breaking Capacity	Spannungsfall Voltage Drop	Leistungs- abgabe Power Dissipation (@1,5 I _n)	Schmelz- integral I ² t ₉₀ Value	Approbationen Approvals		
						Semko	VDE	UL rec.
			mV	W	A ² s			
179200.0,05	50 mA	1500 A @ AC 250 V ¹⁾	1500	0,2	0,02			✓
179200.0,063	63 mA	1500 A @ AC 250 V ¹⁾	1000	0,2	0,05			✓
179200.0,08	80 mA	1500 A @ AC 250 V ¹⁾	2800	0,6	0,02			✓
179200.0,1	100 mA	1500 A @ AC 250 V ¹⁾	2300	0,6	0,02			✓
179200.0,125	125 mA	1500 A @ AC 250 V ¹⁾	2200	0,8	0,045			✓
179200.0,16	160 mA	1500 A @ AC 250 V ¹⁾	2100	0,9	0,08			✓
179200.0,2	200 mA	1500 A @ AC 250 V ¹⁾	1800	0,9	0,14			✓
179200.0,25	250 mA	1500 A @ AC 250 V ¹⁾	1500	1,0	0,25			✓
179200.0,315	315 mA	1500 A @ AC 250 V ¹⁾	1000	1,0	0,45			✓
179200.0,4	400 mA	1500 A @ AC 250 V ¹⁾	850	1,0	0,8			✓
179200.0,5	500 mA	1500 A @ AC 250 V ¹⁾	350	0,4	0,35			✓
179200.0,63	630 mA	1500 A @ AC 250 V ¹⁾	300	0,4	0,6			✓
179200.0,8	800 mA	1500 A @ AC 250 V ¹⁾	300	0,6	1,0			✓
179200.1	1 A ³⁾	1500 A @ AC 250 V ¹⁾	250	0,8	1,5	✓	✓	✓ ³⁾
179200.1,25	1,25 A ³⁾	1500 A @ AC 250 V ¹⁾	200	0,8	3,1	✓	✓	✓ ³⁾
179200.1,6	1,6 A ³⁾	1500 A @ AC 250 V ¹⁾	150	0,8	6,1	✓	✓	✓ ³⁾
179200.2	2 A ³⁾	1500 A @ AC 250 V ¹⁾	130	0,8	5,2	✓	✓	✓ ³⁾
179200.2,5	2,5 A ³⁾	1500 A @ AC 250 V ¹⁾	110	0,9	10	✓	✓	✓ ³⁾
179200.3,15	3,15 A ³⁾	1500 A @ AC 250 V ¹⁾	100	1,0	20	✓	✓	✓ ³⁾
179200.4	4 A ³⁾	1500 A @ AC 250 V ¹⁾	90	1,1	37	✓	✓	✓ ³⁾
179200.5	5 A	1500 A @ AC 250 V ¹⁾	90	1,3	72	✓	✓	✓
179200.6,3	6,3 A	1500 A @ AC 250 V ¹⁾	90	1,6	130	✓	✓	✓
179200.8	8 A	1500 A @ AC 250 V ¹⁾	90	2,0	230			✓
179200.10	10 A	1500 A @ AC 250 V ¹⁾	90	2,5	370			✓
179200.12,5	12,5 A ²⁾	1500 A @ AC 250 V	70	3,1	630			
179200.16	16 A ²⁾	1500 A @ AC 250 V	70	3,9	1500			

¹⁾ cosφ = 0,7-0,8 ²⁾ zusätzlich lieferbare Bemessungsströme / non-standard ratings also available
³⁾ ULrec: 1500 A @ DC 300 V, L/R = res.

Type	Abk. Abbr.	Beschreibung Description
179200	SMD	2.000 Stück T&R als SMD Version/ as SMD version (Seite/ Page 500)
	-	100 Stück / Pieces (10 x 10)
	IP	1.000 Stück Industrieverpackung / 1.000 pieces industrial packs
	FC	1.000 Stück mit Farbcode / 1.000 pieces with colour code
	AK	mit montierten Aufsteckkappen/ with assembled push-on caps
z.B./ e.g.	179200.3,15IP	

Type
179200 SMD



Zeit/Strom-Kennlinien
Time-Current Characteristics

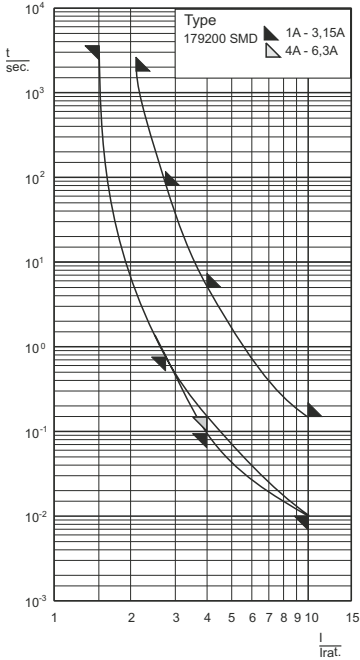

Abmessungen
Dimensions

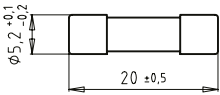

Aufbau / Construction
Keramikrohr / ceramic tube

undurchsichtig / non transparent
mit Löschmittelfüllung / with filling

Kontaktkappen / end caps

Messing, vergoldet / brass, gold-plated

Schmelzeitgrenzwerte / Fusing time limits

Bemessungsstrom Rated Current	1,5 I _n		2,1 I _n		2,75 I _n		4 I _n		10 I _n	
	min.	max.	min.	max.	min.	max.	min.	max.	min.	max.
1 A - 3,15 A	1 h	30 min	750 ms	80 s	95 ms	5 s	10 ms	150 ms		
4 A - 6,3 A	1 h	30 min	750 ms	80 s	150 ms	5 s	10 ms	150 ms		

IEC 60127-2/5 EN 60127-2/5 VDE 0820-2/5	5 x 20 mm	250V	T träge time-lag
---	------------------	------	------------------------

Artikel-Nr. Article-no.	Bemessungs- strom Rated Current	Bemessungs- Ausschaltvermögen Rated Breaking Capacity	Spannungsfall Voltage Drop	Leistungsabgabe Power Dissipa- tion (@1,5 I _n)	Schmelz- integral I ² t ₉₀ Value	Approbationen Approvals
			mV	W	A ² s	UL rec.
179200.1SMD	1 A	1500 A @ AC 250 V ¹⁾	250	0,8	1,5	✓
179200.1,25 SMD	1,25 A	1500 A @ AC 250 V ¹⁾	200	0,8	3,1	✓
179200.1,6SMD	1,6 A	1500 A @ AC 250 V ¹⁾	150	0,8	6,1	✓
179200.2SMD	2 A	1500 A @ AC 250 V ¹⁾	130	0,8	5,2	✓
179200.2,5SMD	2,5 A	1500 A @ AC 250 V ¹⁾	110	0,9	10	✓
179200.3,15SMD	3,15 A	1500 A @ AC 250 V ¹⁾	100	1,0	20	✓
179200.4SMD	4 A	1500 A @ AC 250 V ¹⁾	90	1,1	37	✓
179200.5SMD	5 A	1500 A @ AC 250 V ¹⁾	90	1,3	72	✓
179200.6,3SMD	6,3 A	1500 A @ AC 250 V ¹⁾	90	1,6	130	✓

¹⁾ cosφ = 0,7-0,8

Type	Abk. Abbr.	Beschreibung Description
	SMD	2.000 Stück T&R / 2.000 pieces T&R

Weitere zylindrische Sicherungen als SMD Version auf Anfrage /
Further cylindrical fuses as SMD version on request

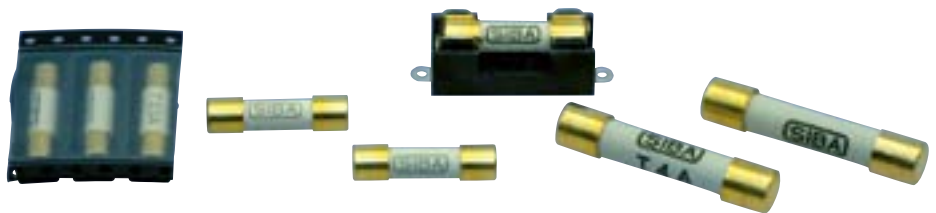

**Type
173100**



**Zeit/Strom-Kennlinien
Time-Current Characteristics**

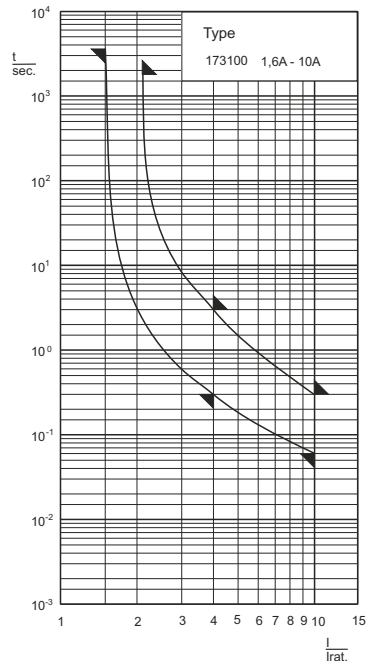

**Abmessungen
Dimensions**

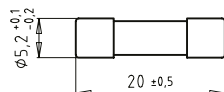

Aufbau / Construction

Glasrohr / glass tube

undurchsichtig / non-transparent
mit Löschmittelfüllung / with filling

Kontaktkappen / end caps

Messing, vernickelt / brass, nickel-plated

Schmelzeitgrenzwerte / Fusing time limits

Bemessungsstrom Rated Current	1,5 I _n		2,1 I _n		2,75 I _n		4 I _n		10 I _n	
	min.	max.	min.	max.	min.	max.	min.	max.	min.	max.
1,6 A - 10 A	1 h	30 min	-	-	300 ms	3 s	60 ms	300 ms		

DIN 41571-3	5 x 20 mm	250 V	T träge time-lag
-------------	------------------	-------	------------------------

Artikel-Nr. Article-no.	Bemessungs- strom Rated Current	Bemessungs- Ausschaltvermögen Rated Breaking Capacity	Spannungsfall Voltage Drop	Leistungsab- gabe Power Dissipa- tion (@1,5 I _n)	Schmelzintegral I ² t ₉₀ Value	Approbationen Approvals
			mV	W	A ² s	
173100.1,6	1,6 A	300 A @ AC 250 V	200 ¹⁾	0,8	16	
173100.2	2 A	300 A @ AC 250 V	190 ¹⁾	0,9	26	
173100.2,5	2,5 A	300 A @ AC 250 V	180 ¹⁾	1,1	45	
173100.3,15	3,15 A	300 A @ AC 250 V	140	1,3	72	
173100.4	4 A	300 A @ AC 250 V	135	1,4	130	
173100.5	5 A	300 A @ AC 250 V	130	1,2	150	
173100.6,3	6,3 A	300 A @ AC 250 V	125	1,3	240	
173100.8	8 A	300 A @ AC 250 V	120	1,6	390	
173100.10	10 A	300 A @ AC 250 V	115	1,9	620	
173100.12,5	12,5 ²⁾ A	300 A @ AC 250 V	100	2,8	1150	
173100.15	15 ²⁾ A	300 A @ AC 250 V	80	3,3	1800	
173100.16	16 ²⁾ A	300 A @ AC 250 V	80	3,8	1800	

¹⁾ (max. nach / according to EN 60127-2/5

²⁾ zusätzlich lieferbare Bemessungsströme / non-standard ratings also available

Type	Abk. Abbr.	Beschreibung Description
173100	-	100 Stück / Pieces (10 x 10)
	IP	1.000 Stück Industrieverpackung / 1.000 pieces industrial packs
z.B./ e.g.	173100.1,6IP	

Type
179500



Zeit/Strom-Kennlinien
Time-Current Characteristics

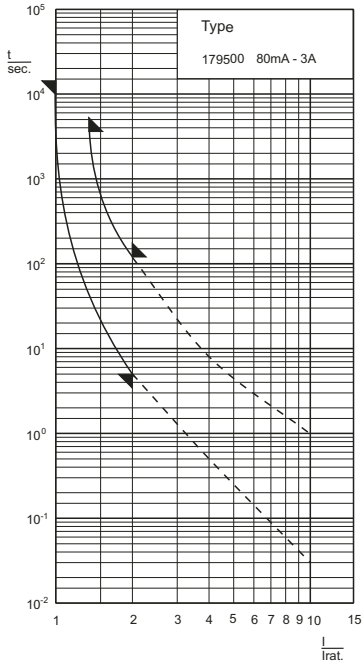

Abmessungen
Dimensions

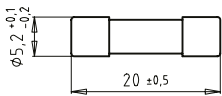

Aufbau / Construction

Glasrohr / glass tube

durchsichtig / transparent

Kontaktkappen / end caps

Messing, vernickelt / brass, nickel-plated

Schmelzeitgrenzwerte / Fusing time limits

Bemessungsstrom Rated Current	100% I _n		135% I _n		200% I _n			
	min.	max.	min.	max.	min.	max.		
80 mA - 3 A	-	-	4 h	-	-	1 h	5 s	120 s

UL 248-14 CSA C22.2 No. 248.14	5 x 20 mm	250 V	T/D träge time delay
-----------------------------------	------------------	-------	----------------------------

Artikel-Nr. Article-no.	Bemessungs- strom Rated Current	Bemessungs- Ausschaltvermögen Rated Breaking Capacity	Spannungsfall Voltage Drop	Leistungsabgabe Power Dissipa- tion (@1,0 I _n)	Schmelz- integral I ² t ₉₀ Value	Approbationen Approvals	
			mV	W	A ² s	UL	cUL
179500.0,08	80 mA	35 A @ AC 250 V ¹⁾	2800	0,3	0,024	✓	✓
179500.0,1	100 mA	35 A @ AC 250 V ¹⁾	2400	0,3	0,053	✓	✓
179500.0,125	125 mA	35 A @ AC 250 V ¹⁾	2100	0,3	0,08	✓	✓
179500.0,15	150 mA	35 A @ AC 250 V ¹⁾	1800	0,3	0,13	✓	✓
179500.0,2	200 mA	35 A @ AC 250 V ¹⁾	1300	0,3	0,24	✓	✓
179500.0,25	250 mA	35 A @ AC 250 V ¹⁾	1100	0,3	0,42	✓	✓
179500.0,3	300 mA	35 A @ AC 250 V ¹⁾	1050	0,4	0,8	✓	✓
179500.0,375	375 mA	35 A @ AC 250 V ¹⁾	900	0,4	1,5	✓	✓
179500.0,4	400 mA	35 A @ AC 250 V ¹⁾	850	0,4	1,6	✓	✓
179500.0,5	500 mA	35 A @ AC 250 V ¹⁾	650	0,4	2,0	✓	✓
179500.0,6	600 mA	35 A @ AC 250 V ¹⁾	550	0,4	3,1	✓	✓
179500.0,7	700 mA	35 A @ AC 250 V ¹⁾	500	0,4	4,5	✓	✓
179500.0,75	750 mA	35 A @ AC 250 V ¹⁾	450	0,4	5,5	✓	✓
179500.0,8	800 mA	35 A @ AC 250 V ¹⁾	400	0,4	6,4	✓	✓
179500.1	1 A	35 A @ AC 250 V ¹⁾	350	0,4	12	✓	✓
179500.1,25	1,25 A	100 A @ AC 250 V ²⁾	300	0,4	19	✓	✓
179500.1,5	1,5 A	100 A @ AC 250 V ²⁾	280	0,5	25	✓	✓
179500.1,6	1,6 A	100 A @ AC 250 V ²⁾	270	0,5	32	✓	✓
179500.2	2 A	100 A @ AC 250 V ²⁾	235	0,5	55	✓	✓
179500.2,5	2,5 A	100 A @ AC 250 V ²⁾	215	0,6	90	✓	✓
179500.3	3 A	100 A @ AC 250 V ²⁾	200	0,6	160	✓	✓

¹⁾ 10 kA @ AC 125 V 35 A @ AC 250 V cosφ = 0,7-0,8
²⁾ 10 kA @ AC 125 V 100 A @ AC 250 V cosφ = 0,7-0,8

Type	Abk. Abbr.	Beschreibung Description
179500		100 Stück / Pieces (10 x 10)
	IP	1.000 Stück Industrieverpackung / 1.000 pieces industrial packs
z.B./ e.g.		179500.1,6IP

Type 190000



Zeit/Strom-Kennlinien
Time-Current Characteristics

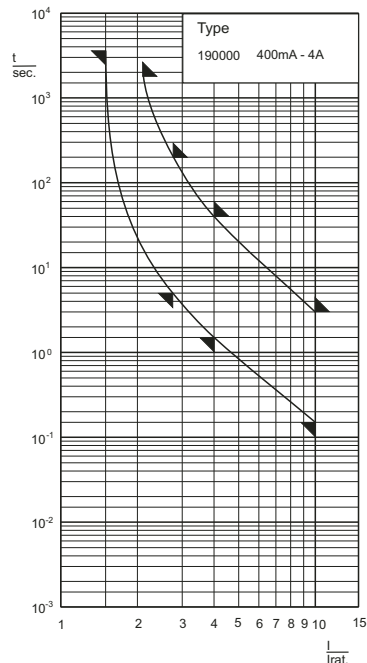

Abmessungen
Dimensions

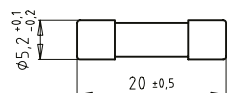

Aufbau / Construction

Glasrohr / glass tube

durchsichtig / transparent

Kontaktkappen / end caps

Messing, vernickelt / brass, nickel-plated

Schmelzeitgrenzwerte / Fusing time limits

Bemessungsstrom Rated Current	1,5 I _n		2,1 I _n		2,75 I _n		4 I _n		10 I _n	
	min.	max.	min.	max.	min.	max.	min.	max.	min.	max.
400 mA - 4 A	1 h	30 min	5 s	200 s	1,5 s	40 s	150 ms	3 s		

Sondertyp Special type	5 x 20 mm	250 V	TT superträge very time-lag
---------------------------	------------------	-------	-----------------------------------

Artikel-Nr. Article-no.	Bemessungsstrom Rated Current	Bemessungs-Ausschaltvermögen Rated Breaking Capacity	Spannungsfall Voltage Drop	Leistungsabgabe Power Dissipation (@1,5 I _n)	Schmelzintegral I ² t _s Value	Approbationen Approvals
190000.0,4	400 mA	35 A @ AC 250 V	500 mV	0,3 mW	2,5 A's	
190000.0,5	500 mA	35 A @ AC 250 V	450 mV	0,3 mW	4,6 A's	
190000.0,63	630 mA	35 A @ AC 250 V	400 mV	0,3 mW	10 A's	
190000.0,8	800 mA	35 A @ AC 250 V	300 mV	0,4 mW	15 A's	
190000.1	1 A	35 A @ AC 250 V	250 mV	0,4 mW	26 A's	
190000.1,25	1,25 A	35 A @ AC 250 V	200 mV	0,4 mW	37 A's	
190000.1,6	1,6 A	35 A @ AC 250 V	200 mV	0,5 mW	45 A's	
190000.2	2 A	35 A @ AC 250 V	200 mV	0,6 mW	72 A's	
190000.2,5	2,5 A	35 A @ AC 250 V	150 mV	0,6 mW	130 A's	
190000.3,15	3,15 A	35 A @ AC 250 V	150 mV	0,6 mW	230 A's	
190000.4	4 A	40 A @ AC 250 V	100 mV	0,8 mW	370 A's	

Type	Abk. Abbr.	Beschreibung Description
190000	-	100 Stück / Pieces (10 x 10)
	IP	1.000 Stück Industrieverpackung / 1.000 pieces industrial packs
z.B./ e.g.	190000.ZIP	

Type 179901	Sortiment / Assortment	F (IEC 60127-2/2, Type 179020)
------------------------	-------------------------------	--------------------------------

Type 179900	Sortiment / Assortment	T (IEC 60127-2/3, Type 179120)
------------------------	-------------------------------	--------------------------------

Type 172900	Sortiment / Assortment	M (DIN 41571-2, Type 172000 / 172100)
------------------------	-------------------------------	---------------------------------------

Inhalt / Contents

Sicherungseinsätze / fuse-links 5 x 20 mm
18 x 20 = 360 Stück / pieces

Je 20 Stück / 20 pcs. each:
100 mA, 125 mA, 160 mA, 200 mA, 250 mA,
315 mA, 400 mA, 500 mA, 630 mA, 800 mA,
1 A, 1,25 A, 1,6 A, 2 A, 2,5 A, 3,15 A, 4 A, 6,3 A

Type 7500101	Sortiment / Assortment	F (IEC 60127-2/2, Type 179020) & T (IEC 60127-2/3, Type 179120)
-------------------------	-------------------------------	---

Inhalt / Contents

Sicherungseinsätze / fuse-links 5 x 20 mm
36 x 10 = 360 Stück / pieces

F 179020; 100 mA - 10 A
T 179120; 400 mA - 10 A



Type 189701	Sortiment / Assortment	F (IEC 60127-2/4, Type 189000)
------------------------	-------------------------------	--------------------------------

Type 189700	Sortiment / Assortment	T (Sondertype / Special type 189100)
------------------------	-------------------------------	--------------------------------------

Inhalt / Contents

Sicherungseinsätze / fuse-links 6,3 x 32 mm
12 x 10 = 120 Stück / pieces

Je 10 Stück / 10 pcs. each:
500 mA, 800 mA, 1 A, 1,25 A, 1,6 A, 2 A, 2,5 A, 3,15 A, 4 A, 5 A, 6,3 A, 10 A



Type 171525

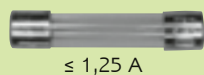

≤ 1,25 A

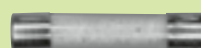

> 1,25 A

F

Type 172525



≤ 1,25 A



> 1,25 A

M

Zeit/Strom-Kennlinien
Time-Current Characteristics

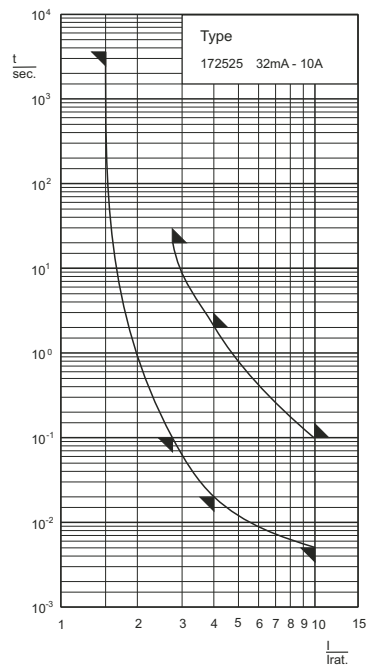
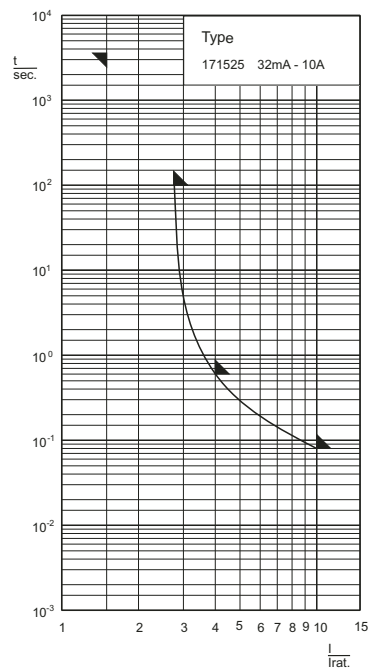

Abmessungen
Dimensions

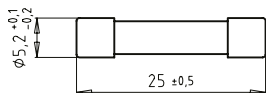

Aufbau / Construction

Glasrohr / glass tube

bis 1,25 A durchsichtig / up to 1,25 A transparent
ab 1,25 A undurchsichtig / from 1.25 A non transparent
mit Löschmittelfüllung / with filling

Kontaktkappen / end caps

Messing, vernickelt / brass, nickel-plated

Schmelzeitgrenzwerte / Fusing time limits

Bemessungsstrom Rated Current	1,5 I _n		2,75 I _n		4 I _n		10 I _n	
	min.	max.	min.	max.	min.	max.	min.	max.
32 mA - 10 A (Type 171525)	1 h	-	-	100 s	-	600 ms	-	80 ms
32 mA - 10 A (Type 172525)	1 h	-	100 ms	20 s	20 ms	2 s	5 ms	100 ms

Sondertyp Special type	5 x 25 mm	250 V	F flink / quick acting M mittelträge / med. time lag
---------------------------	------------------	-------	---

Artikel-Nr. Article-no.	Artikel-Nr. Article-no.	Bemessungsstrom Rated Current	Bemessungs- Ausschaltvermögen Rated Breaking Capacity	Approbationen Approvals
F	M			
171525.0,032	172525.0,032	32 mA	50 A @ AC 250 V	
171525.0,05	172525.0,05	50 mA	50 A @ AC 250 V	
171525.0,063	172525.0,063	63 mA	50 A @ AC 250 V	
171525.0,08	172525.0,08	80 mA	50 A @ AC 250 V	
171525.0,1	172525.0,1	100 mA	50 A @ AC 250 V	
171525.0,125	172525.0,125	125 mA	50 A @ AC 250 V	
171525.0,16	172525.0,16	160 mA	50 A @ AC 250 V	
171525.0,2	172525.0,2	200 mA	50 A @ AC 250 V	
171525.0,25	172525.0,25	250 mA	50 A @ AC 250 V	
171525.0,315	172525.0,315	315 mA	50 A @ AC 250 V	
171525.0,4	172525.0,4	400 mA	50 A @ AC 250 V	
171525.0,5	172525.0,5	500 mA	50 A @ AC 250 V	
171525.0,63	172525.0,63	630 mA	50 A @ AC 250 V	
171525.0,8	172525.0,8	800 mA	50 A @ AC 250 V	
171525.1	172525.1	1 A	50 A @ AC 250 V	
171525.1,25	172525.1,25	1,25 A	50 A @ AC 250 V	
171525.1,6	172525.1,6	1,6 A	80 A @ AC 250 V	
171525.2	172525.2	2 A	80 A @ AC 250 V	
171525.2,5	172525.2,5	2,5 A	80 A @ AC 250 V	
171525.3,15	172525.3,15	3,15 A	80 A @ AC 250 V	
171525.4	172525.4	4 A	80 A @ AC 250 V	
171525.5	172525.5	5 A	80 A @ AC 250 V	
171525.6,3	172525.6,3	6,3 A	80 A @ AC 250 V	
171525.8	172525.8	8 A	80 A @ AC 250 V	
171525.10	172525.10	10 A	80 A @ AC 250 V	

Type	Abk. Abbr.	Beschreibung Description
	-	100 Stück/ Pieces (10 x 10)

Type
171526



Zeit/Strom-Kennlinien
Time-Current Characteristics

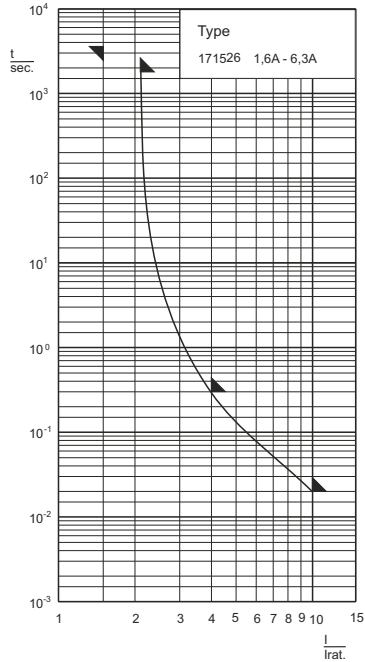

Abmessungen
Dimensions

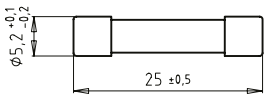

Aufbau / Construction
Keramicrohr / ceramic tube

Kontaktkappen / end caps

undurchsichtig / non-transparent
mit Löschmittelfüllung / with filling

Messing vernickelt / brass nickel-plated

mit Kennmelder / with indicator

Schmelzeitgrenzwerte / Fusing time limits

Bemessungsstrom Rated Current	1,5 I _n		2,1 I _n		2,75 I _n		4 I _n		10 I _n	
	min.	max.	min.	max.	min.	max.	min.	max.	min.	max.
1,6 A - 6,3 A	1 h	30 min	-	-	-	-	300 ms	-	-	20 ms

DIN 41576-1	5 x 25 mm	250 V	F flink quick acting
-------------	------------------	-------	----------------------------

Artikel-Nr. Article-no.	Bemessungs- strom Rated Current	Bemessungs- Ausschaltvermögen Rated Breaking Capacity	Spannungsfall Voltage Drop	Leistungsabgabe Power Dissipa- tion (@1,5 I _n)	Schmelz- integral I ² t ₉₀ Value	Kennmelderfarbe Color code	
						deutsch	english
171526.1,6	1,6 A	1500 A @ AC 250 V	640	0,9	2,3	orange	orange
171526.2	2 A	1500 A @ AC 250 V	420	1,1	2,4	blau	blue
171526.2,5	2,5 A	1500 A @ AC 250 V	320	1,2	4	gelb	yellow
171526.3,15	3,15 A	1500 A @ AC 250 V	250	1,4	6,5	schwarz	black
171526.4	4 A	1500 A @ AC 250 V	200	1,7	16	braun	brown
171526.5	5 A	1500 A @ AC 250 V	180	2,1	33	weiß	white
171526.6,3	6,3 A	1500 A @ AC 250 V	170	2,5	63	grün	green
171526.8	8 A	1500 A @ AC 250 V	150	3,0	100	grau	grey
171526.10	10 A	1500 A @ AC 250 V	120	3,3	200	rot	red

Type	Abk. Abbr.	Beschreibung Description
	-	100 Stück / Pieces (10 x 10)

Type 172526

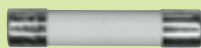

Zeit/Strom-Kennlinien
Time-Current Characteristics

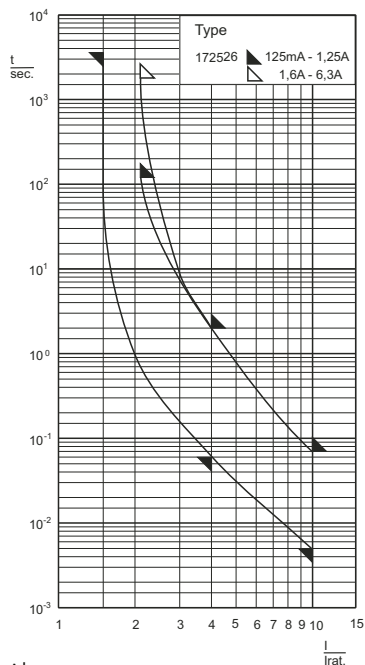
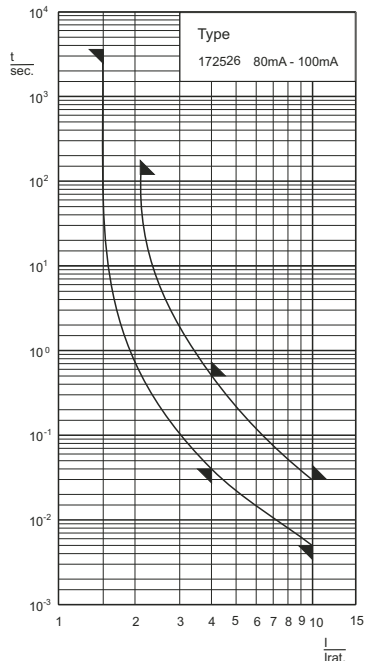

Abmessungen
Dimensions

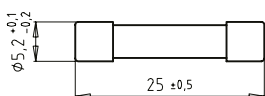

Aufbau / Construction

Keramikrohr / ceramic tube

undurchsichtig / non-transparent
mit Löschmittelfüllung (ab 1,6 A) /
with filling (1,6 A up)

Kontaktkappen / end caps

Messing vernickelt / brass nickel-plated

mit Kennmelder / with indicator

Schmelzeitgrenzwerte / Fusing time limits

Bemessungsstrom Rated Current	1,5 I _n		2,1 I _n		2,75 I _n		5 I _n		10 I _n	
	min.	max.	min.	max.	min.	max.	min.	max.	min.	max.
80 mA - 100 mA	1 h	2 min	-	-	40 ms	500 ms	5 ms	30 ms		
125 mA - 1,25 A	1 h	2 min	-	-	60 ms	2 s	5 ms	70 ms		
1,6 A - 6,3 A	1 h	30 min	-	-	60 ms	2 s	5 ms	70 ms		

DIN 41576-2	5 x 25 mm	250 V	M mittelträge medium time-lag
-------------	------------------	-------	-------------------------------------

Artikel-Nr. Article-no.	Bemessungsstrom Rated Current	Bemessungs-Ausschaltvermögen Rated Breaking Capacity	Spannungsfall Voltage Drop	Leistungsabgabe Power Dissipation (@1,5 I _n)	Schmelzintegral I ² t ₅ Value	Kennmelderfarbe Color code	
						deutsch	english
172526.0,05	50 mA	80 A @ AC 250 V	520	0,1	0,005	weiß	white
172526.0,063	63 mA	80 A @ AC 250 V	520	0,1	0,007	grün	green
172526.0,08	80 mA	80 A @ AC 250 V	520	0,1	0,009	grau	grey
172526.0,1	100 mA	80 A @ AC 250 V	500	0,1	0,022	rot	red
172526.0,125	125 mA	80 A @ AC 250 V	500	0,1	0,041	violett	lilac
172526.0,16	160 mA	80 A @ AC 250 V	400	0,1	0,1	orange	orange
172526.0,2	200 mA	80 A @ AC 250 V	400	0,2	0,2	blau	blue
172526.0,25	250 mA	150 A @ AC 250 V	375	0,2	0,22	gelb	yellow
172526.0,315	315 mA	150 A @ AC 250 V	410	0,2	0,21	schwarz	black
172526.0,4	400 mA	150 A @ AC 250 V	280	0,2	0,56	braun	brown
172526.0,5	500 mA	150 A @ AC 250 V	250	0,2	1,1	weiß	white
172526.0,63	630 mA	150 A @ AC 250 V	220	0,2	0,7	grün	green
172526.0,8	800 mA	150 A @ AC 250 V	400	0,2	1,6	grau	grey
172526.1	1 A	150 A @ AC 250 V	350	0,2	3,5	rot	red
172526.1,25	1,25 A	150 A @ AC 250 V	315	0,4	5,5	violett	lilac
172526.1,6	1,6 A	150 A @ AC 250 V	480	0,6	5,6	orange	orange
172526.2	2 A	150 A @ AC 250 V	360	0,7	9,6	blau	blue
172526.2,5	2,5 A	150 A @ AC 250 V	300	0,9	15	gelb	yellow
172526.3,15	3,15 A	150 A @ AC 250 V	250	1,1	24	schwarz	black
172526.4	4 A	150 A @ AC 250 V	180	1,3	40	braun	brown
172526.5	5 A	150 A @ AC 250 V	180	1,5	87	weiß	white
172526.6,3	6,3 A	150 A @ AC 250 V	160	1,8	170	grün	green
172526.8	8 A	150 A @ AC 250 V	150	3	190	grau	grey
172526.10	10 A	150 A @ AC 250 V	150	3,2	370	rot	red

Type	Abk. Abbr.	Beschreibung Description
		- 100 Stück/ Pieces (10 x 10)

**Type
7008913**



Zeit/Strom-Kennlinien
Time-Current Characteristics

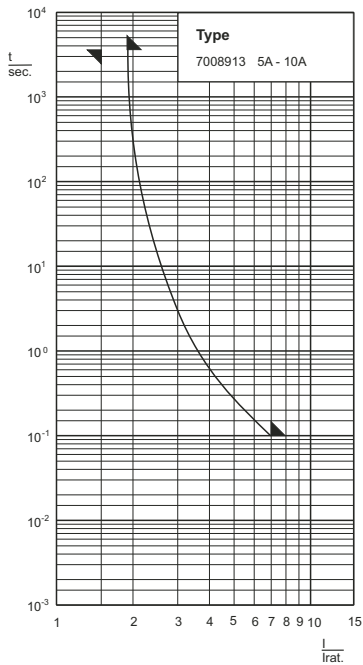
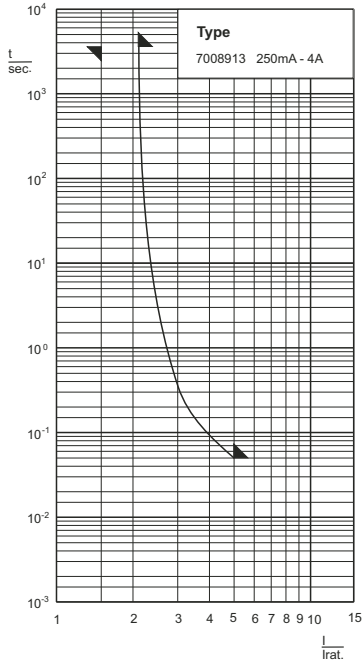

Abmessungen
Dimensions

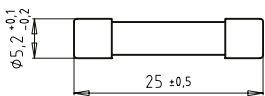

Aufbau / Construction

Keramikrohr / ceramic tube

undurchsichtig / non-transparent

Kontaktkappen / end caps

Messing vernickelt / brass nickel-plated

mit Kennmelder / with indicator

Zubehör / Related Products

Aufbausicherungshalter 7104403 und Schraubkappe 7204402 siehe Liste M

suitable fuse-holder for panel mounting No. 7104403 and screw-cap No. 7204402 see catalog M

Schmelzeitgrenzwerte / Fusing time limits

Bemessungsstrom Rated Current	1,5 I _n		1,9 I _n		2,1 I _n		5 I _n		7 I _n	
	min.	max.	min.	max.	min.	max.	min.	max.	min.	max.
500 mA - 4 A	1 h	-	-	-	1 h	-	50 ms	-	-	-
5 A - 10 A	1 h	1 h	-	-	-	-	-	-	-	100 ms

VG 88851	5 x 25 mm	450 V	F flink quick acting
----------	------------------	-------	----------------------------

Artikel-Nr. Article-no.	Bemessungsstrom Rated Current	Bemessungs-Ausschaltvermögen Rated Breaking Capacity	Spannungsfall Voltage Drop	Leistungsabgabe Power Dissipation (@ 1,5 I _n)	Schmelzintegral I ² t _s Value	Kennmelderfarbe Color code
			mV	W	A ² s	deutsch english
7008913.0,25	250 mA	70 kA @ AC 500 V ¹⁾	950	0,3	0,05	gelb yellow
7008913.0,315	315 mA	70 kA @ AC 500 V ¹⁾	900	0,5	0,05	schwarz black
7008913.0,4	400 mA	70 kA @ AC 500 V ¹⁾	800	0,5	0,15	braun brown
7008913.0,5	500 mA	70 kA @ AC 500 V ¹⁾	700	0,6	0,15	weiß white
7008913.0,8	800 mA	70 kA @ AC 500 V ¹⁾	300	0,3	0,25	grau grey
7008913.1	1 A	70 kA @ AC 500 V ¹⁾	300	0,3	0,5	rot red
7008913.1,25	1,25 A	70 kA @ AC 500 V ¹⁾	250	0,4	1,1	violett lilac
7008913.1,6	1,6 A	70 kA @ AC 500 V ¹⁾	400	0,9	2,3	orange orange
7008913.2	2 A	70 kA @ AC 500 V ¹⁾	400	1,1	2,4	blau blue
7008913.2,5	2,5 A	70 kA @ AC 500 V ¹⁾	350	1,2	4	gelb yellow
7008913.3,15	3,15 A	70 kA @ AC 500 V ¹⁾	300	1,4	6,5	schwarz black
7008913.4	4 A	70 kA @ AC 500 V ¹⁾	200	1,7	16	braun brown
7008913.5	5 A	70 kA @ AC 500 V ¹⁾	200	2,1	33	weiß white
7008913.6,3	6,3 A	70 kA @ AC 500 V ¹⁾	150	2,5	63	grün green
7008913.8	8 A	70 kA @ AC 500 V ¹⁾	190	6	13	grau grey
7008913.10	10 A	70 kA @ AC 500 V ¹⁾	150	5	32	rot red

¹⁾ 10 kA @ DC 250 V

Type	Abk. Abbr.	Beschreibung Description
	-	100 Stück/ Pieces (10 x 10)

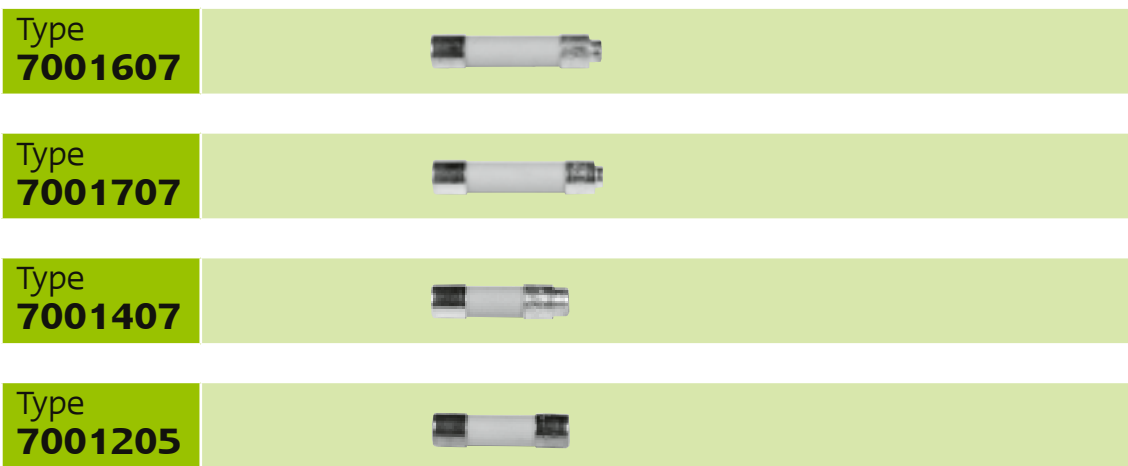

Abmessungen
Dimensions

7001607 / 7001707

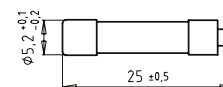

7001407

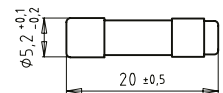

7001205

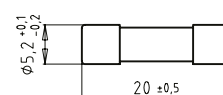

Zeit/Strom-Kennlinien
Time-Current Characteristics

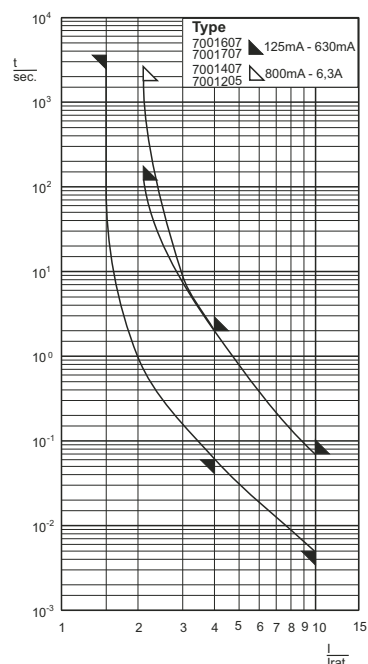
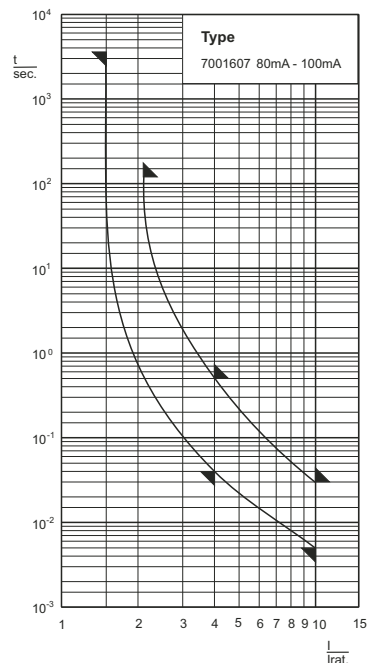

Aufbau / Construction

Keramikrohr / ceramic tube

undurchsichtig / non-transparent

Kontaktkappen / end caps

Messing vernickelt / brass nickel-plated

mit Kennmelder / with indicator

Schmelzeitgrenzwerte / Fusing time limits

Bemessungsstrom Rated Current	1,5 I _n		2,1 I _n		4 I _n		10 I _n	
	min.	max.	min.	max.	min.	max.	min.	max.
80 mA - 100 mA	1 h	-	-	2 min	40 ms	500 ms	5 ms	30 ms
125 mA - 630 mA	1 h	-	-	2 min	60 ms	2 s	5 ms	70 ms
800 mA - 6,3 A	1 h	-	-	30 min	60 ms	2 s	5 ms	70 ms

DIN 41577 T.2	5 x L mm	250 V	M mittelträge medium time-lag
---------------	-----------------	-------	-------------------------------------

Artikel-Nr. Article-no.	Bemessungsstrom Rated Current	Bemessungs-Ausschaltvermögen Rated Breaking Capacity	Spannungsfall Voltage Drop	Leistungsabgabe Power Dissipation (@ 1,5 I _n)	Schmelzintegral I ² t ₅ Value	Länge L Length L
			mV	W	A ² s	mm
7001607.0,08	80 mA	80 A @ AC 250 V	520	0,1	0,017	25
7001607.0,1	100 mA	80 A @ AC 250 V	500	0,1	0,022	25
7001607.0,125	125 mA	80 A @ AC 250 V	500	0,1	0,041	25
7001607.0,16	160 mA	80 A @ AC 250 V	400	0,1	0,1	25
7001607.0,2	200 mA	80 A @ AC 250 V	400	0,2	0,2	25
7001707.0,25	250 mA	1500 A @ AC 250 V	500	0,2	0,22	25
7001707.0,315	315 mA	1500 A @ AC 250 V	470	0,2	0,31	25
7001707.0,4	400 mA	1500 A @ AC 250 V	400	0,2	0,56	25
7001707.0,5	500 mA	1500 A @ AC 250 V	400	0,2	1,1	25
7001707.0,63	630 mA	1500 A @ AC 250 V	380	0,2	0,7	25
7001407.0,8	800 mA	1500 A @ AC 250 V	400	0,3	1,6	20
7001407.1	1 A	1500 A @ AC 250 V	350	0,3	3,5	20
7001407.1,25	1,25 A	1500 A @ AC 250 V	310	0,3	5,5	20
7001407.1,6	1,6 A	1500 A @ AC 250 V	480	1	5,6	20
7001407.2	2 A	1500 A @ AC 250 V	360	1	9,6	20
7001407.2,5	2,5 A	1500 A @ AC 250 V	300	1,1	15	20
7001407.3,15	(3,15) A ¹⁾	1500 A @ AC 250 V	250	1,2	24	20
7001407.4	4 A	1500 A @ AC 250 V	180	1,3	40	20
7001205.6,3 ²⁾	6,3 A	1500 A @ AC 250 V	160	1,8	170	20

¹⁾ nicht genormt / non standardized

²⁾ ohne Passzapfen / without fitting device

Type	Abk. Abbr.	Beschreibung Description
	-	100 Stück/ Pieces (10 x 10)

Type
171530



≤ 1,25 A



> 1,25 A

F

Type
172530



≤ 1,25 A



> 1,25 A

M

Zeit/Strom-Kennlinien
Time-Current Characteristics

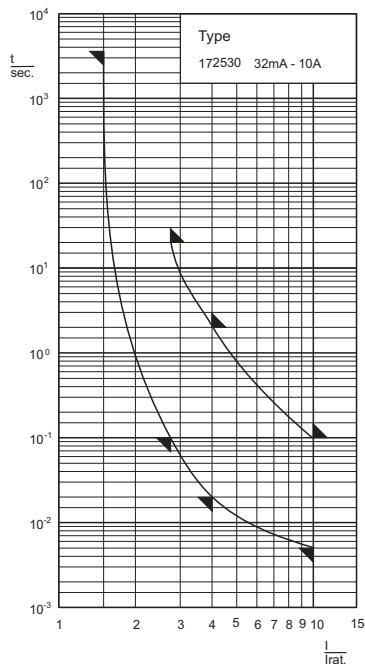
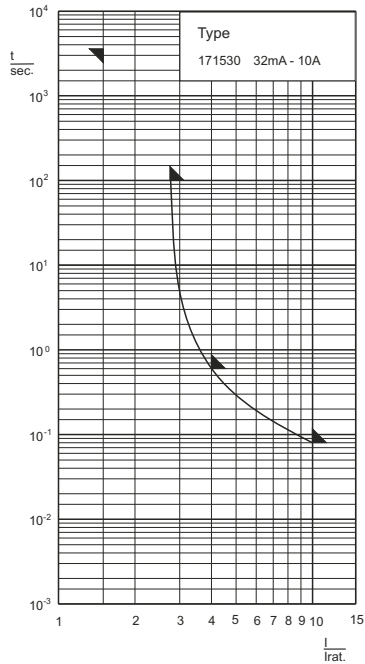

Aufbau / Construction

Glasrohr / glass tube

bis 1,25 A durchsichtig / up to 1,25 A transparent
ab 1,25 A undurchsichtig / from 1.25 A non transparent
mit Löschmittelfüllung / with filling

Kontaktkappen / end caps

Messing, vernickelt / brass, nickel-plated

Schmelzeitgrenzwerte / Fusing time limits

Bemessungsstrom Rated Current	1,5 I _n		2,75 I _n		4 I _n		10 I _n	
	min.	max.	min.	max.	min.	max.	min.	max.
32 mA - 10 A (Type 171530)	1 h	-	-	100 s	-	600 ms	-	80 ms
32 mA - 10 A (Type 172530)	1 h	-	50 ms	30 s	20 ms	2 s	5 ms	100 ms

Sondertyp Special type	5 x 30 mm	500 V	F flink / quick acting M mittelträge / med. time-lag
---------------------------	------------------	-------	---

Artikel-Nr. Article-no.	Artikel-Nr. Article-no.	Bemessungsstrom Rated Current	Bemessungs- Ausschaltvermögen Rated Breaking Capacity	Approbationen Approvals
F	M			
171530.0,032	172530.0,032	32 mA	50 A @ AC 500 V	
171530.0,05	172530.0,05	50 mA	50 A @ AC 500 V	
171530.0,063	172530.0,063	63 mA	50 A @ AC 500 V	
171530.0,08	172530.0,08	80 mA	50 A @ AC 500 V	
171530.0,1	172530.0,1	100 mA	50 A @ AC 500 V	
171530.0,125	172530.0,125	125 mA	50 A @ AC 500 V	
171530.0,16	172530.0,16	160 mA	50 A @ AC 500 V	
171530.0,2	172530.0,2	200 mA	50 A @ AC 500 V	
171530.0,25	172530.0,25	250 mA	50 A @ AC 500 V	
171530.0,315	172530.0,315	315 mA	50 A @ AC 500 V	
171530.0,4	172530.0,4	400 mA	50 A @ AC 500 V	
171530.0,5	172530.0,5	500 mA	50 A @ AC 500 V	
171530.0,63	172530.0,63	630 mA	50 A @ AC 500 V	
171530.0,8	172530.0,8	800 mA	50 A @ AC 500 V	
171530.1	172530.1	1 A	50 A @ AC 500 V	
171530.1,25	172530.1,25	1,25 A	50 A @ AC 500 V	
171530.1,6	172530.1,6	1,6 A	80 A @ AC 500 V	
171530.2	172530.2	2 A	80 A @ AC 500 V	
171530.2,5	172530.2,5	2,5 A	80 A @ AC 500 V	
171530.3,15	172530.3,15	3,15 A	80 A @ AC 500 V	
171530.4	172530.4	4 A	80 A @ AC 500 V	
171530.5	172530.5	5 A	80 A @ AC 500 V	
171530.6,3	172530.6,3	6,3 A	80 A @ AC 500 V	
171530.8	172530.8	8 A	80 A @ AC 500 V	
171530.10	172530.10	10 A	80 A @ AC 500 V	

Abmessungen
Dimensions

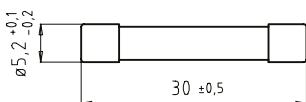

Type	Abk. Abbr.	Beschreibung Description
	-	100 Stück/ Pieces (10 x 10)

Type
7012540



Zeit/Strom-Kennlinien
Time-Current Characteristics

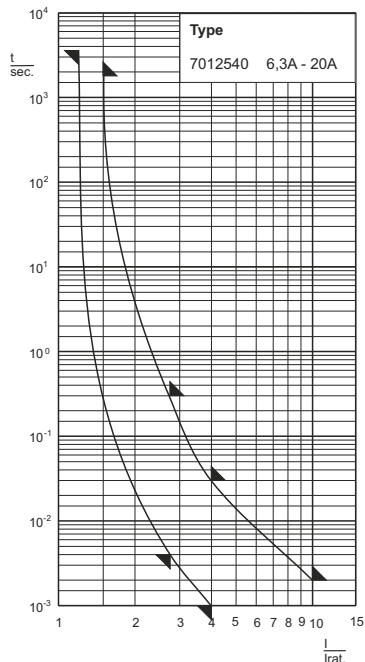
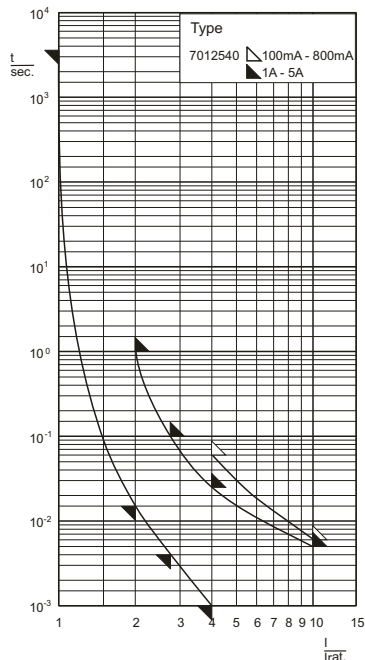

Abmessungen
Dimensions

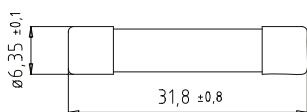

Aufbau / Construction
Keramikrohr / ceramic tube

undurchsichtig / non transparent
mit Löschmittelfüllung / with filling

Kontaktkappen / end caps

Messing, vernickelt / brass, nickel-plated

Schmelzeitgrenzwerte / Fusing time limits

Bemessungsstrom Rated Current	1 I _n		1,2 I _n		2,75 I _n		4 I _n		10 I _n	
	min.	min.	min.	max.	min.	max.	min.	max.	min.	max.
100 mA - 800 mA	1 h	-	-	-	-	60 ms	-	-	-	6 ms
1 A - 5 A	1 h	-	4 ms	150 ms	1 ms	25 ms	-	-	-	5 ms
6,3 A - 20 A	-	1 h	4 ms	300 ms	1 ms	30 ms	-	-	-	2 ms

Sondertyp Special type	6,3 x 32 mm (0,25 x 1,25")	700 V 600 V 500 V	FF superflink very quick acting
---------------------------	--------------------------------------	-------------------------	---------------------------------------

Artikel-Nr. Article-no.	Bemessungs- strom Rated Current	Bemessungs- Ausschaltvermögen Rated Breaking Capacity	Spannungsfall Voltage Drop	Leistungsabgabe Power Dissipa- tion (@ 1,0/1,2 I _n)	Schmelz- integral I ² t _z Value	Approbationen Approvals
			mV	W	A ² s	UL rec.
7012540.0,1	100 mA	50 kA @ AC 700 V ¹⁾	2500	0,3	0,0009	✓
7012540.0,125	125 mA	50 kA @ AC 700 V ¹⁾	2200	0,3	0,0017	✓
7012540.0,16	160 mA	50 kA @ AC 700 V ¹⁾	2000	0,4	0,004	✓
7012540.0,2	200 mA	50 kA @ AC 700 V ¹⁾	900	0,2	0,01	✓
7012540.0,25	250 mA	50 kA @ AC 700 V ¹⁾	800	0,2	0,02	✓
7012540.0,315	315 mA	50 kA @ AC 700 V ¹⁾	700	0,3	0,04	✓
7012540.0,4	400 mA	50 kA @ AC 700 V ¹⁾	650	0,3	0,07	✓
7012540.0,5	500 mA	50 kA @ AC 700 V ¹⁾	650	0,4	0,12	✓
7012540.0,63	630 mA	50 kA @ AC 700 V ¹⁾	650	0,5	0,15	✓
7012540.0,8	800 mA	50 kA @ AC 700 V ¹⁾	600	0,5	0,23	✓
7012540.1	1 A	50 kA @ AC 700 V ¹⁾	750	0,8	0,32	✓
7012540.1,25	1,25 A	50 kA @ AC 700 V ¹⁾	700	0,9	0,20	✓
7012540.1,6	1,6 A	50 kA @ AC 700 V ¹⁾	650	1,1	0,31	✓
7012540.2	2 A	50 kA @ AC 700 V ¹⁾	650	1,4	0,64	✓
7012540.2,5	2,5 A	50 kA @ AC 600 V ¹⁾	550	1,4	1,2	✓
7012540.3,15	3,15 A	50 kA @ AC 600 V ¹⁾	500	1,6	2,0	✓
7012540.4	4 A	50 kA @ AC 600 V ¹⁾	450	1,8	5,0	✓
7012540.5	5 A	50 kA @ AC 600 V ¹⁾	400	2,0	10	✓
7012540.6,3	6,3 A	50 kA @ AC 600 V ¹⁾	400	4	3,0	✓
7012540.8	8 A	50 kA @ AC 600 V	350	4,5	6,5	✓
7012540.10	10 A	50 kA @ AC 600 V	350	5	12	✓
7012540.12,5	12,5 A	50 kA @ AC 500 V	300	7	18	✓
7012540.16	16 A	50 kA @ AC 500 V	300	9	31	✓
7012540.20	20 A	50 kA @ AC 500 V	300	11	46	✓
7012540.25	25 A	50 kA @ AC 500 V	230	11	87	✓

Bei Verwendung dieser G-Sicherungseinsätze ab 6,3 A ist auf ausreichende Wärmeabfuhr zu achten.
When using this type from 6.3 A up, consideration should be given to heat dissipation

¹⁾ 20 kA @ DC 500 V ohne/without Approbation/Approval

Type	Abk. Abbr.	Beschreibung Description
7012540	-	100 Stück / Pieces (10 x 10)
	IP	1.000 Stück Industrieverpackung / 1.000 pieces industrial packs
z.B./ e.g.		7012540.16IP

Type
7017240



Zeit/Strom-Kennlinien
Time-Current Characteristics

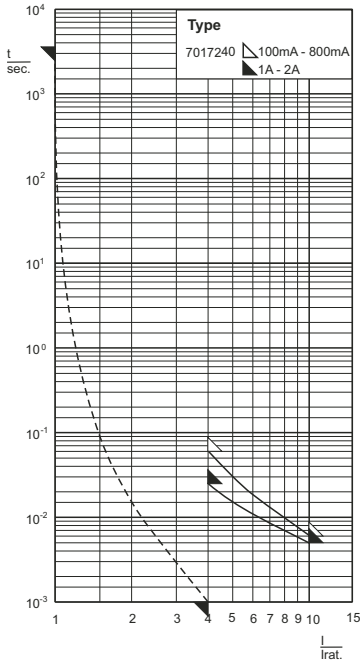

Abmessungen
Dimensions

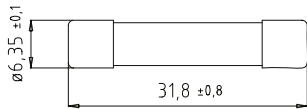

Aufbau / Construction
Keramikrohr / ceramic tube

undurchsichtig / non transparent
mit Löschmittelfüllung / with filling

Kontaktkappen / end caps

Messing, vernickelt / brass, nickel-plated

Schmelzeitgrenzwerte / Fusing time limits

Bemessungsstrom Rated Current	1,0 I _n		2,75 I _n		4 I _n		10 I _n		
	min.	max.	min.	max.	min.	max.	min.	max.	
100 mA - 800 mA	1 h	-	-	-	-	-	60 ms	-	6 ms
1 A - 2 A	1 h	-	-	-	1 ms	25 ms	-	6ms	

nur für Kurzschlusschutz for short circuit protection only	6,3 x 32 mm (0,25 x 1,25")	1000 V	aR (FF)
---	--------------------------------------	--------	---------

Artikel-Nr. Article-no.	Bemessungsstrom Rated Current	Bemessungs-Ausschaltvermögen Rated Breaking Capacity	Spannungsfall Voltage Drop	Leistungsabgabe Power Dissipation (@ 1,0 I _n)	Schmelzintegral I ² t _s Value	Approbationen Approvals
			mV	W	A ² s	UL rec.
7017240.0,1	100 mA	30 kA@AC/DC 1000 V ¹⁾	2500	0,3	0,0009	✓
7017240.0,125	125 mA	30 kA@AC/DC 1000 V ¹⁾	2200	0,3	0,0017	✓
7017240.0,16	160 mA	30 kA@AC/DC 1000 V ¹⁾	2000	0,4	0,004	✓
7017240.0,2	200 mA	30 kA@AC/DC 1000 V ¹⁾	900	0,2	0,01	✓
7017240.0,25	250 mA	30 kA@AC/DC 1000 V ¹⁾	800	0,2	0,02	✓
7017240.0,315	315 mA	30 kA@AC/DC 1000 V ¹⁾	700	0,3	0,04	✓
7017240.0,4	400 mA	30 kA@AC/DC 1000 V ¹⁾	650	0,3	0,07	✓
7017240.0,5	500 mA	30 kA@AC/DC 1000 V ¹⁾	650	0,4	0,12	✓
7017240.0,63	630 mA	30 kA@AC/DC 1000 V	650	0,5	0,15	✓
7017240.0,8	800 mA	30 kA@AC/DC 1000 V	600	0,5	0,23	✓
7017240.1	1 A	30 kA@AC/DC 1000 V	750	0,8	0,32	✓
7017240.1,6	1,6 A	30 kA@AC/DC 1000 V	650	1,1	0,31	✓
7017240.2	2 A	30 kA @ DC 1000 V	650	1,4	0,64	✓

¹⁾ 50kA @ AC/DC 1000V ohne/without Approval/Approval

Type	Abk. Abbr.	Beschreibung Description
7017240	-	100 Stück / Pieces (10 x 10)
	IP	1.000 Stück Industrieverpackung / 1.000 pieces industrial packs
z.B./ e.g.	7017240.1,6IP	

Type 7006584



Zeit/Strom-Kennlinien
Time-Current Characteristics

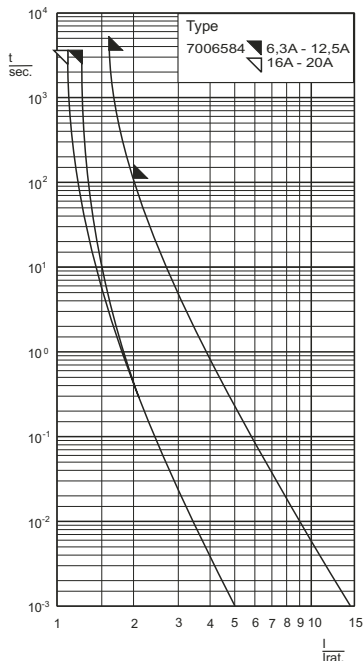

Abmessungen
Dimensions

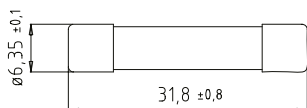

Aufbau / Construction
Keramikrohr / ceramic tube

undurchsichtig / non transparent
mit Löschmittelfüllung / with filling

Kontaktkappen / end caps

Messing, vernickelt / brass, nickel-plated

Schmelzeitgrenzwerte / Fusing time limits

Bemessungsstrom Rated Current	1,1 I _n		1,25 I _n		1,6 I _n		2,0 I _n		
	min.	max.	min.	max.	min.	max.	min.	max.	
6,3 A - 12,5 A	-	-	1 h	-	-	-	1 h	-	120 s
16 A - 20 A	1 h	-	-	-	-	-	1 h	-	120 s

IEC 60269-4 VDE 0636 Teil 4	6,3 x 32 mm (0,25 x 1,25")	400 V	gRL
--------------------------------	--------------------------------------	-------	-----

Artikel-Nr. Article-no.	Bemessungsstrom Rated Current	Bemessungs-Ausschaltvermögen Rated Breaking Capacity	Spannungsfall Voltage Drop	Leistungsabgabe Power Dissipation (@ 1,0 I _n)	Schmelzintegral I ² t ₅ Value	Ausschaltintegral Total I ² t ₅ Value @ AC 400 V	Approbationen Approvals
			mV	W	A ² s	A ² s	UL rec.
7006584.6,3	6,3 A	120 kA @ AC 400 V	190	1,2	1,8	11	✓
7006584.8	8 A	120 kA @ AC 400 V	190	1,5	3,0	18	✓
7006584.10	10 A	120 kA @ AC 400 V	180	1,8	5,1	31	✓
7006584.12,5	12,5 A	120 kA @ AC 400 V	150	1,9	12	69	✓
7006584.16	16 A	120 kA @ AC 400 V	150	2,3	20	120	✓
7006584.20	20 A	120 kA @ AC 400 V	160	3,2	35	210	✓

Type	Abk. / Abbr.	Beschreibung / Description
7006584	-	100 Stück / Pieces (10 x 10)
	IP	1.000 Stück Industrieverpackung / 1.000 pieces industrial packs
z.B./ e.g.		7006584.12,5IP

Type
189000



Zeit/Strom-Kennlinien
Time-Current Characteristics

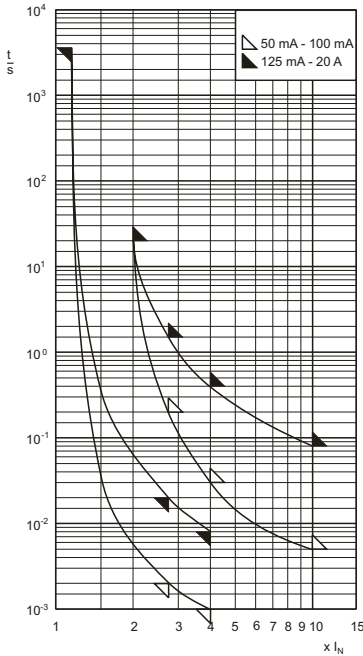

Abmessungen
Dimensions

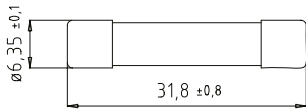

Aufbau / Construction

Glasrohr / glass tube

durchsichtig / transparent

Kontaktkappen / end caps

Messing, vernickelt / brass, nickel-plated

Schmelzeitgrenzwerte / Fusing time limits

Bemessungsstrom Rated Current	2 I _n		2,75 I _n		4 I _n		10 I _n	
	min.	max.	min.	max.	min.	max.	min.	max.
50 mA - 100 mA	-	20 s	2 ms	200 ms	1 ms	30 ms	-	5 ms
125 mA - 20 A	-	20 s	20 ms	1,5 s	8 ms	400 ms	-	80 ms

(IEC 60127-2/4)	6,3 x 32 mm (0,25 x 1,25")	250 V	F flink quick acting
-----------------	--------------------------------------	-------	----------------------------

Artikel-Nr. Article-no.	Bemessungsstrom Rated Current	Bemessungs-Ausschaltvermögen Rated Breaking Capacity	Spannungsfall Voltage Drop	Leistungsabgabe Power Dissipation (@ 1,15 I _n)	Schmelzintegral I ² t _s Value	Approbationen Approvals
			mV	W	A ² s	
189000.0,05	50 mA	35 A @ AC 250 V	9600	0,7	0,0003	
189000.0,063	63 mA	35 A @ AC 250 V	6000	0,5	0,0005	
189000.0,08	80 mA	35 A @ AC 250 V	5000	0,6	0,001	
189000.0,1	100 mA	35 A @ AC 250 V	4500	0,7	0,0014	
189000.0,125	125 mA	35 A @ AC 250 V	4000	0,7	0,0034	
189000.0,16	160 mA	35 A @ AC 250 V	3500	0,8	0,007	
189000.0,2	200 mA	35 A @ AC 250 V	650	0,2	0,02	
189000.0,25	250 mA	35 A @ AC 250 V	650	0,3	0,04	
189000.0,315	315 mA	35 A @ AC 250 V	600	0,3	0,08	
189000.0,4	400 mA	35 A @ AC 250 V	500	0,3	0,15	
189000.0,5	500 mA	35 A @ AC 250 V	450	0,3	0,32	
189000.0,63	630 mA	35 A @ AC 250 V	400	0,4	0,26	
189000.0,8	800 mA	35 A @ AC 250 V	350	0,4	0,57	
189000.1	1 A	35 A @ AC 250 V	300	0,5	1,1	
189000.1,25	1,25 A	35 A @ AC 250 V	300	0,6	2	
189000.1,6	1,6 A	35 A @ AC 250 V	300	0,7	3,3	
189000.2	2 A	35 A @ AC 250 V	250	0,8	6,2	
189000.2,5	2,5 A	35 A @ AC 250 V	220	0,9	13	
189000.3,15	3,15 A	35 A @ AC 250 V	200	1,1	24	
189000.4	4 A	40 A @ AC 250 V	200	1,3	40	
189000.5	5 A	50 A @ AC 250 V	180	1,4	80	
189000.6,3	6,3 A	63 A @ AC 250 V	170	1,6	150	
189000.8	8 A	80 A @ AC 250 V	160	2	240	
189000.10	10 A	100 A @ AC 250 V	150	2,3	500	
189000.12,5	12,5 A	125 A @ AC 250 V	140	2,5	650	
189000.16	16 A	160 A @ AC 250 V	130	2,8	1250	
189000.20	20 A	200 A @ AC 250 V	130	4,0	1600	

Bei Verwendung dieser G-Sicherungseinsätze ab 6,3 A ist auf ausreichende Wärmeabfuhr zu achten.
When using this type from 6.3 A up, consideration should be given to heat dissipation.

Type	Abk. Abbr.	Beschreibung Description
189000	-	100 Stück / Pieces (10 x 10)
	IP	1.000 Stück Industrieverpackung / 1.000 pieces industrial packs
	AK	mit montierten Aufsteckkappen/ with assembled push-on caps
z.B./ e.g.		189000.3,15IP

Type
189020

CAUS
E167295



Zeit/Strom-Kennlinien
Time-Current Characteristics

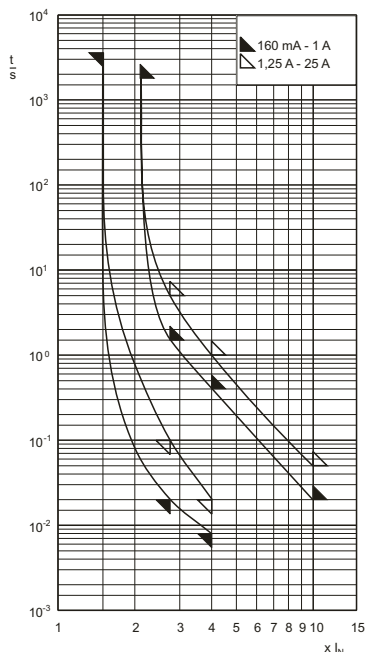

Abmessungen
Dimensions

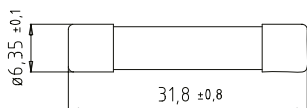

Auch als SMD Version verfügbar
Also available as SMD version
1 A - 5 A



Aufbau / Construction
Keramikrohr / ceramic tube

undurchsichtig / non transparent
mit Löschmittelfüllung / with filling

Kontaktkappen / end caps

Messing, vernickelt / brass, nickel-plated

Schmelzeitgrenzwerte / Fusing time limits

Bemessungsstrom Rated Current	1,5 I _n		2,1 I _n		2,75 I _n		4 I _n		10 I _n	
	min.	max.	min.	max.	min.	max.	min.	max.	min.	max.
160 mA - 1 A	1 h	30 min	20 ms	1,5 s	8 ms	400 ms	-	20 ms	-	-
1,25 A - 25 A	1 h	30 min	100 ms	5 s	20 ms	1 s	-	50 ms	-	-

Sondertyp Special type	6,3 x 32 mm (0,25 x 1,25")	500 V 440 V	F flink quick acting
---------------------------	--------------------------------------	----------------	----------------------------

Artikel-Nr. Article-no.	Bemessungsstrom Rated Current	Bemessungs-Ausschaltvermögen Rated Breaking Capacity	Spannungsfall Voltage Drop	Leistungsabgabe Power Dissipation (@ 1,5 I _n)	Schmelzintegral I ² t ₅₀ Value	Approbationen Approvals
			mV	W	A ² s	UL rec.
189020.0,16	160 mA	50 kA @ AC 500 V ¹⁾	7000	2,5	0,0015	✓
189020.0,2	200 mA	50 kA @ AC 500 V ¹⁾	6500	2,9	0,0035	✓
189020.0,25	250 mA	50 kA @ AC 500 V ¹⁾	6000	3,4	0,0085	✓
189020.0,315	315 mA	50 kA @ AC 500 V ¹⁾	1000	0,9	0,036	✓
189020.0,4	400 mA	50 kA @ AC 500 V ¹⁾	900	1,0	0,07	✓
189020.0,5	500 mA	50 kA @ AC 500 V ¹⁾	800	1,1	0,19	✓
189020.0,63	630 mA	50 kA @ AC 500 V ¹⁾	700	1,3	0,35	✓
189020.0,8	800 mA	50 kA @ AC 500 V ¹⁾	600	1,4	0,49	✓
189020.1	1 A	50 kA @ AC 500 V ¹⁾	400	1,2	0,4	✓
189020.1,25	1,25 A	50 kA @ AC 500 V ¹⁾	300	1,3	0,8	✓
189020.1,6	1,6 A	50 kA @ AC 500 V ¹⁾	300	1,4	1,5	✓
189020.2	2 A	50 kA @ AC 500 V ¹⁾	280	1,6	2,5	✓
189020.2,5	2,5 A	50 kA @ AC 500 V ¹⁾	260	1,8	5	✓
189020.3,15	3,15 A	50 kA @ AC 500 V ¹⁾	240	2,3	9	✓
189020.4	4 A	50 kA @ AC 500 V ¹⁾	220	2,6	18	✓
189020.5	5 A	50 kA @ AC 500 V ¹⁾	190	2,9	40	✓
189020.6,3	6,3 A	50 kA @ AC 500 V ¹⁾	170	3,2	80	✓
189020.8	8 A	1,5 kA @ AC 500 V ²⁾	160	3,7	150	
189020.10	10 A	1,5 kA @ AC 500 V ²⁾	150	4,0	240	
189020.12,5	12,5 A	1,5 kA @ AC 500 V ²⁾	140	5,5	500	
189020.16	16 A	1,5 kA @ AC 500 V ²⁾	130	6,5	920	
189020.20	20 A	1,5 kA @ AC 440 V ²⁾	120	8,4	1500	
189020.25	25 A	1,5 kA @ AC 440 V ²⁾	110	11	3100	

¹⁾ $\cos\phi = 0,3$ 1500 A @ DC 450 V resistiv

²⁾ $\cos\phi = 1$

Bei Verwendung dieser G-Sicherungseinsätze ab 6,3 A ist auf ausreichende Wärmeabfuhr zu achten.
When using this type from 6.3 A up, consideration should be given to heat dissipation.

Type	Abk. Abbr.	Beschreibung Description
189020	-	100 Stück / Pieces (10 x 10)
	IP	1.000 Stück Industrieverpackung / 1.000 pieces industrial packs
	AK	mit montierten Aufsteckkappen / with assembled push-on caps
z.B./ e.g.	189020.3,15AK	

Type
7009463



Zeit/Strom-Kennlinien
Time-Current Characteristics

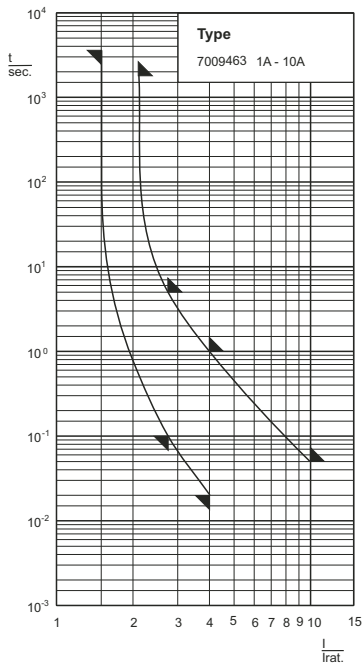
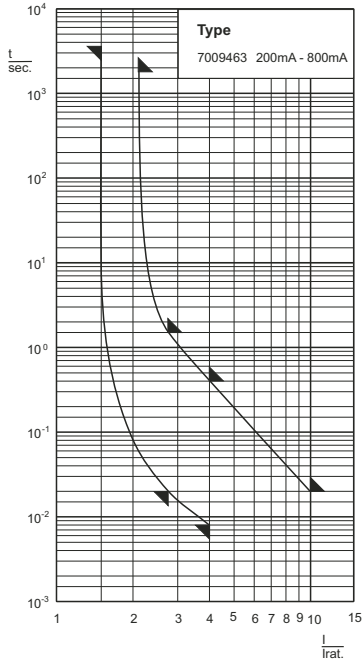

Abmessungen
Dimensions

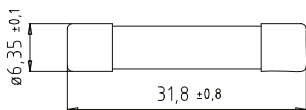

Aufbau / Construction
Keramikrohr / ceramic tube

undurchsichtig / non transparent
mit Löschmittelfüllung / with filling

Kontaktkappen / end caps

Messing, vernickelt / brass, nickel-plated

Schmelzeitgrenzwerte / Fusing time limits

Bemessungsstrom Rated Current	1,5 I _n		2,1 I _n		2,75 I _n		4 I _n		10 I _n	
	min.	max.	min.	max.	min.	max.	min.	max.	min.	max.
200 mA - 800 mA	1 h	30 min	20 ms	1,5 s	8 ms	400 ms	-	20 ms		
1 A - 10 A	1 h	30 min	100 ms	5 s	20 ms	1 s	-	50 ms		

Sondertype Special type	6,3 x 32 mm (0,25 x 1,25")	600 V	F flink quick acting
----------------------------	--------------------------------------	-------	----------------------------

Artikel-Nr. Article-no.	Bemessungsstrom Rated Current	Bemessungs-Ausschaltvermögen Rated Breaking Capacity	Spannungsfall Voltage Drop	Leistungsabgabe Power Dissipation (@ 1,5 I _n)	Schmelzintegral I ² t _s Value	Approbationen Approvals
			mV	W	A ² s	
7009463.0,2	200 mA	50 kA @ AC 600 V	6500	2,9	0,0035	
7009463.0,4	400 mA	50 kA @ AC 600 V	900	1,0	0,07	
7009463.0,5	500 mA	50 kA @ AC 600 V	800	1,1	0,19	
7009463.0,8	800 mA	50 kA @ AC 600 V	600	1,4	0,49	
7009463.1	1 A	50 kA @ AC 600 V	400	1,2	0,4	
7009463.2	2 A	50 kA @ AC 600 V	280	1,6	2,5	
7009463.3	3 A	50 kA @ AC 600 V	260	2,2	7,5	
7009463.5	5 A	50 kA @ AC 600 V	190	2,9	40	
7009463.7	7 A	50 kA @ AC 600 V	150	3,8	100	
7009463.10	10 A	50 kA @ AC 600 V	150	4,0	240	

Bei Verwendung dieser G-Sicherungsinsätze ab 7 A ist auf ausreichende Wärmeabfuhr zu achten.
When using this type from 7 A up, consideration should be given to heat dissipation.

Type	Abk. Abbr.	Beschreibung Description
	-	100 Stück / Pieces (10 x 10)
7009463	IP	1.000 Stück Industrieverpackung / 1.000 pieces industrial packs
	AK	mit montierten Aufsteckkappen/ with assembled push-on caps
z.B./ e.g.	7009463.10IP	

Type 189100



Zeit/Strom-Kennlinien Time-Current Characteristics

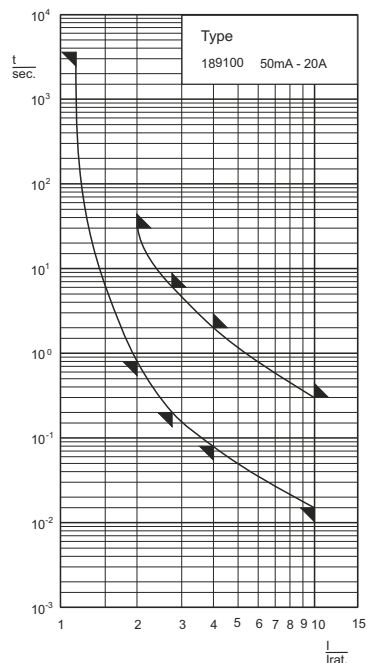

Abmessungen Dimensions

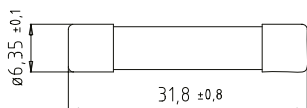

Aufbau / Construction

Glasrohr / glass tube

durchsichtig / transparent

Kontaktkappen / end caps

Messing, vernickelt / brass, nickel-plated

Schmelzeitgrenzwerte / Fusing time limits

Bemessungsstrom Rated Current	$2 I_n$		$2,75 I_n$		$4 I_n$		$10 I_n$	
	min.	max.	min.	max.	min.	max.	min.	max.
50 mA - 20 A	800 ms	30 s	200 ms	6 s	80 ms	2 s	15 ms	300 ms

Sondertyp Special type	6,3 x 32 mm (0,25 x 1,25")	250 V	T träge time-lag
---------------------------	--------------------------------------	-------	------------------------

Artikel-Nr. Article-no.	Bemessungs- strom Rated Current	Bemessungs- Ausschaltvermögen Rated Breaking Capacity	Spannungsfall Voltage Drop	Leistungsabgabe Power Dissipa- tion (@ 1,15 I _n)	Schmelz- integral I ² t ₉₀ Value	Approbationen Approvals
			mV	W	A ² s	
189100.0,05	50 mA	35 A @ AC 250 V	3000	0,3	0,035	
189100.0,063	63 mA	35 A @ AC 250 V	2500	0,3	0,04	
189100.0,08	80 mA	35 A @ AC 250 V	2000	0,3	0,08	
189100.0,1	100 mA	35 A @ AC 250 V	1500	0,3	0,17	
189100.0,125	125 mA	35 A @ AC 250 V	1200	0,3	0,26	
189100.0,16	160 mA	35 A @ AC 250 V	1100	0,4	0,44	
189100.0,2	200 mA	35 A @ AC 250 V	1000	0,4	0,6	
189100.0,25	250 mA	35 A @ AC 250 V	900	0,5	0,6	
189100.0,315	315 mA	35 A @ AC 250 V	300	0,2	0,35	
189100.0,4	400 mA	35 A @ AC 250 V	300	0,2	0,49	
189100.0,5	500 mA	35 A @ AC 250 V	300	0,3	0,9	
189100.0,63	630 mA	35 A @ AC 250 V	300	0,3	1,4	
189100.0,8	800 mA	35 A @ AC 250 V	250	0,4	3,2	
189100.1	1 A	35 A @ AC 250 V	250	0,4	6,5	
189100.1,25	1,25 A	35 A @ AC 250 V	250	0,4	5	
189100.1,6	1,6 A	35 A @ AC 250 V	200	0,5	10	
189100.2	2 A	35 A @ AC 250 V	200	0,6	16	
189100.2,5	2,5 A	35 A @ AC 250 V	200	0,7	24	
189100.3,15	3,15 A	35 A @ AC 250 V	200	0,8	42	
189100.4	4 A	40 A @ AC 250 V	200	1,0	70	
189100.5	5 A	50 A @ AC 250 V	200	1,3	130	
189100.6,3	6,3 A	63 A @ AC 250 V	200	1,6	230	
189100.8	8 A	80 A @ AC 250 V	200	2,0	370	
189100.10	10 A	100 A @ AC 250 V	150	2,3	630	
189100.12,5	12,5 A	125 A @ AC 250 V	150	2,8	820	
189100.15	15 A	150 A @ AC 250 V	150	2,9	925	
189100.16	16 A	160 A @ AC 250 V	150	3,0	1200	
189100.20	20 A	200 A @ AC 250 V	150	4,0	1600	

Bei Verwendung dieser G-Sicherungseinsätze ab 6,3 A ist auf ausreichende Wärmeabfuhr zu achten.
When using this type from 6.3 A up, consideration should be given to heat dissipation.

Type	Abk. Abbr.	Beschreibung Description
	-	100 Stück / Pieces (10 x 10)
189100	IP	1.000 Stück Industrieverpackung / 1.000 pieces industrial packs
	AK	mit montierten Aufsteckkappen/ with assembled push-on caps
z.B./ e.g.	189100.2IP	

Type
189140



Zeit/Strom-Kennlinien
Time-Current Characteristics

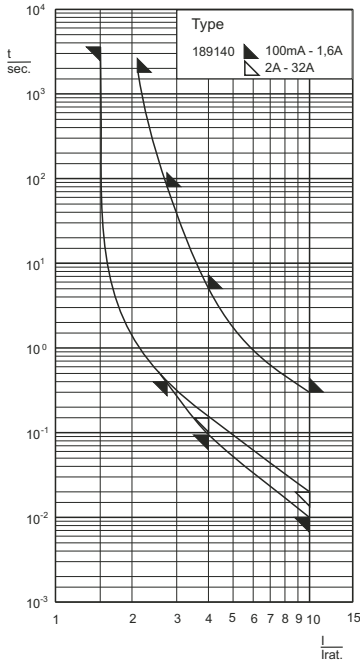

Abmessungen
Dimensions

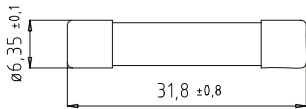

Auch als SMD Version verfügbar
Also available as SMD version
1 A - 6,3 A



Aufbau / Construction
Keramikrohr / ceramic tube

undurchsichtig / non transparent
mit Löschmittelfüllung / with filling

Kontaktkappen / end caps

Messing, vernickelt / brass, nickel-plated

Schmelzeitgrenzwerte / Fusing time limits

Bemessungsstrom Rated Current	1,5 I _n		2,1 I _n		2,75 I _n		4 I _n		10 I _n	
	min.	max.	min.	max.	min.	max.	min.	max.	min.	max.
100 mA - 1,6 A	1 h	30 min	400 ms	80 s	95 ms	5 s	10 ms	300 ms		
2 A - 32 A	1 h	30 min	400 ms	80 s	150 ms	5 s	20 ms	300 ms		

Sondertyp Special type	6,3 x 32 mm (0,25 x 1,25")	500 V 440 V 250 V	T träge time-lag
---------------------------	--------------------------------------	-------------------------	------------------------

Artikel-Nr. Article-no.	Bemessungsstrom Rated Current	Bemessungs-Ausschaltvermögen Rated Breaking Capacity	Spannungsfall Voltage Drop	Leistungsabgabe Power Dissipation (@ 1,5 I _n)	Schmelzintegral I ² t ₉₀ Value	Approbationen Approvals
		mV		W	A ² s	UL rec.
189140.0,1	100 mA	1,5 kA @ AC 500 V ¹⁾	3600	1,3	0,04	✓
189140.0,125	125 mA	1,5 kA @ AC 500 V ¹⁾	3400	1,4	0,06	✓
189140.0,16	160 mA	1,5 kA @ AC 500 V ¹⁾	3000	1,5	0,1	✓
189140.0,2	200 mA	1,5 kA @ AC 500 V ¹⁾	2500	1,6	0,18	✓
189140.0,25	250 mA	1,5 kA @ AC 500 V ¹⁾	2000	1,7	0,25	✓
189140.0,315	315 mA	1,5 kA @ AC 500 V ¹⁾	1800	1,8	0,45	✓
189140.0,4	400 mA	1,5 kA @ AC 500 V ¹⁾	1600	2,0	0,45	✓
189140.0,5	500 mA	1,5 kA @ AC 500 V ¹⁾	450	0,6	0,35	✓
189140.0,63	630 mA	1,5 kA @ AC 500 V ¹⁾	400	0,7	0,49	✓
189140.0,8	800 mA	1,5 kA @ AC 500 V ¹⁾	350	0,8	0,9	✓
189140.1	1 A	1,5 kA @ AC 500 V ¹⁾	350	0,9	1,4	✓
189140.1,25	1,25 A	1,5 kA @ AC 500 V ¹⁾	300	1,0	3,2	✓
189140.1,6	1,6 A	1,5 kA @ AC 500 V ¹⁾	200	1,1	5,2	✓
189140.2	2 A	1,5 kA @ AC 500 V ¹⁾	180	1,2	10	✓
189140.2,5	2,5 A	1,5 kA @ AC 500 V ¹⁾	160	1,3	19	✓
189140.3,15	3,15 A	1,5 kA @ AC 500 V ²⁾	150	1,4	37	✓
189140.4	4 A	1,5 kA @ AC 500 V ²⁾	140	1,5	68	✓
189140.5	5 A	1,5 kA @ AC 500 V ²⁾	135	2,2	80	✓
189140.6,3	6,3 A	1,5 kA @ AC 500 V ²⁾	110	2,2	215	✓
189140.8	8 A	1,5 kA @ AC 500 V ¹⁾	110	2,6	370	✓
189140.10	10 A	1,5 kA @ AC 500 V ¹⁾	100	3,0	620	✓
189140.12,5	12,5 A	1,5 kA @ AC 500 V ³⁾	100	3,5	1300	✓
189140.16	16 A	1,5 kA @ AC 500 V ³⁾	100	4	2500	✓
189140.20	20 A	1,5 kA @ AC 440 V ³⁾	100	6	3400	
189140.25	25 A	1,5 kA @ AC 440 V ³⁾	100	8	5600	
189140.32	32 A	1,5 kA @ AC 250 V ³⁾	80	10	3900	

¹⁾ cosφ = 1 1,5kA @ DC 400 V (ohne Approbation / without approval)

²⁾ cosφ = 1 **ULrec: 1,5kA @ DC 400 V**

³⁾ cosφ = 1 1,5kA @ DC 300 V (ohne Approbation / without approval)

Bei Verwendung dieser G-Sicherungseinsätze ab 6,3 A ist auf ausreichende Wärmeabfuhr zu achten.
When using this type from 6.3 A up, consideration should be given to heat dissipation.

Type	Abk. Abbr.	Beschreibung Description
189140	-	100 Stück / Pieces (10 x 10)
	IP	1.000 Stück Industrieverpackung / 1.000 pieces industrial packs
	AK	mit montierten Aufsteckkappen/ with assembled push-on caps
z.B./ e.g.		189140.1,6IP

Type 189500



Zeit/Strom-Kennlinien
Time-Current Characteristics

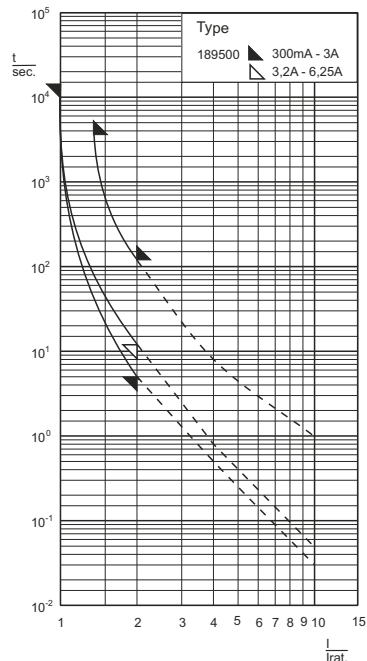

Abmessungen
Dimensions

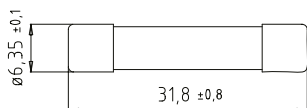

Aufbau / Construction

Glasrohr / glass tube

durchsichtig / transparent

Kontaktkappen / end caps

Messing, vernickelt / brass, nickel-plated

Schmelzeitgrenzwerte / Fusing time limits

Bemessungsstrom Rated Current	100% I _n		135% I _n		200% I _n		
	min.	max.	min.	max.	min.	max.	
300 mA - 3 A	-	-	4 h	-	-	1 h	5 s
3,2 A - 6,25 A	-	-	4 h	-	-	1 h	12 s

UL 248-14 CSA C22.5 No. 248.14	6,3 x 32 mm (0,25 x 1,25")	250 V 125 V	T/D träge time-delay
-----------------------------------	--------------------------------------	----------------	----------------------------

Artikel-Nr. Article-no.	Bemessungsstrom Rated Current	Bemessungs-Ausschaltvermögen Rated Breaking Capacity	Spannungsfall Voltage Drop	Leistungsabgabe Power Dissipation (@ 1,0 In)	Schmelzintegral I ² t _s Value	Approbationen Approvals
			mV	W	A ² s	
189500.0,3	300 mA	100 A @ AC 250 V ¹⁾	870	0,26	1,5	
189500.0,375	375 mA	100 A @ AC 250 V ¹⁾	840	0,32	2,5	
189500.0,4	400 mA	100 A @ AC 250 V ¹⁾	730	0,29	2,5	
189500.0,5	500 mA	100 A @ AC 250 V ¹⁾	660	0,33	5,4	
189500.0,6	600 mA	100 A @ AC 250 V ¹⁾	600	0,36	3,1	
189500.0,7	700 mA	100 A @ AC 250 V ¹⁾	580	0,41	4,5	
189500.0,8	800 mA	100 A @ AC 250 V ¹⁾	500	0,4	6,4	
189500.1	1 A	100 A @ AC 250 V ¹⁾	450	0,45	13	
189500.1,25	1,25 A	100 A @ AC 250 V ¹⁾	400	0,5	19	
189500.1,5	1,5 A	100 A @ AC 250 V ¹⁾	370	0,56	25	
189500.1,6	1,6 A	100 A @ AC 250 V ¹⁾	350	0,56	32	
189500.2	2 A	100 A @ AC 250 V ¹⁾	330	0,66	55	
189500.2,5	2,5 A	100 A @ AC 250 V ¹⁾	290	0,73	90	
189500.2,8	2,8 A	100 A @ AC 250 V ¹⁾	270	0,76	120	
189500.3	3 A	100 A @ AC 250 V ¹⁾	250	0,75	160	
189500.3,2	3,2 A	100 A @ AC 250 V ¹⁾	220	0,7	350	
189500.4	4 A	10 kA @ AC 125 V ²⁾	200	0,8	590	
189500.5	5 A	10 kA @ AC 125 V ²⁾	200	1	600	
189500.6,25	6,25 A	10 kA @ AC 125 V ²⁾	200	1,3	1300	

¹⁾ 10 kA @ AC 125 V 100 A @ AC 250 V cosφ = 0,7-0,8
²⁾ 10 kA @ AC 125 V cosφ = 0,7-0,8

Type	Abk. Abbr.	Beschreibung Description
189500	-	100 Stück / Pieces (10 x 10)
	IP	1.000 Stück Industrieverpackung / 1.000 pieces industrial packs
	AK	mit montierten Aufsteckkappen/ with assembled push-on caps
z.B./ e.g.	189500.1,25IP	

Type
7006526



Zeit/Strom-Kennlinien
Time-Current Characteristics

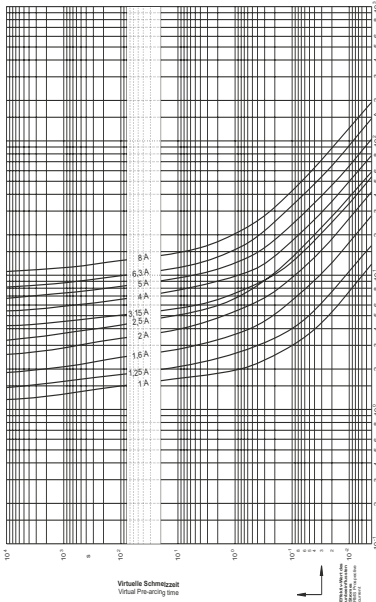

Abmessungen
Dimensions

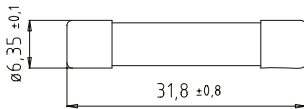

Aufbau / Construction
Keramikrohr / ceramic tube

undurchsichtig / non transparent
mit Löschmittelfüllung / with filling

Kontaktkappen / end caps

Kupferlegierung, vernickelt / Copper alloy,
nickel-plated

Schmelzeitgrenzwerte / Fusing time limits

Bemessungsstrom Rated Current	1,1 I _n		1,45 I _n					
	min.	max.	min.	max.	min.	max.	min.	max.
1 A - 8 A	1 h	-	-	1 h	-	-	-	-

In Anlehnung an IEC 60269-4 Following IEC 60269-4	6,3 x 32 mm (0,25 x 1,25")	400 V	gPV (für Photovoltaik Anwendungen/ for photovoltaic applications)
--	--------------------------------------	-------	--

Artikel-Nr. Article-no.	Bemessungsstrom Rated Current	Bemessungs-Ausschaltvermögen Rated Breaking Capacity	Spannungsfall Voltage Drop	Leistungsabgabe Power Dissipation (@ 1,0 I _n)	Schmelzintegral I ² t ₅ Value	Ausschaltintegral Total I ² t ₅ Value @ DC 400 V	Approbationen Approvals
			mV	W	A ² s	A ² s	
7006526.1	1 A	30 kA @ DC 400 V	600	0,6	0,58	1,1	
7006526.1,25	1,25 A	30 kA @ DC 400 V	500	0,63	1,1	2,2	
7006526.1,6	1,6 A	30 kA @ DC 400 V	375	0,6	3,2	6,5	
7006526.2	2 A	30 kA @ DC 400 V	300	0,6	7,1	15	
7006526.2,5	2,5 A	30 kA @ DC 400 V	270	0,7	14	30	
7006526.3,15	3,15 A	30 kA @ DC 400 V	250	0,8	11	22	
7006526.4	4 A	30 kA @ DC 400 V	220	0,9	23	50	
7006526.5	5 A	30 kA @ DC 400 V	210	1,1	42	85	
7006526.6,3	6,3 A	30 kA @ DC 400 V	200	1,3	83	150	
7006526.8	8 A	30 kA @ DC 400 V	175	1,4	150	300	

Type	Abk. Abbr.	Beschreibung Description
	-	100 Stück / Pieces (10 x 10)
7006526	IP	1.000 Stück Industrieverpackung / 1.000 pieces industrial packs
	AK	mit montierten Aufsteckkappen/ with assembled push-on caps
z.B./ e.g.		7006526.3,15IP

Type
183000

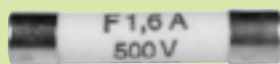

Zeit/Strom-Kennlinien
Time-Current Characteristics

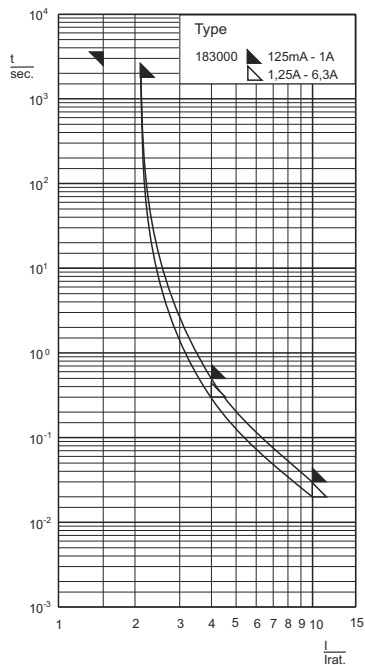
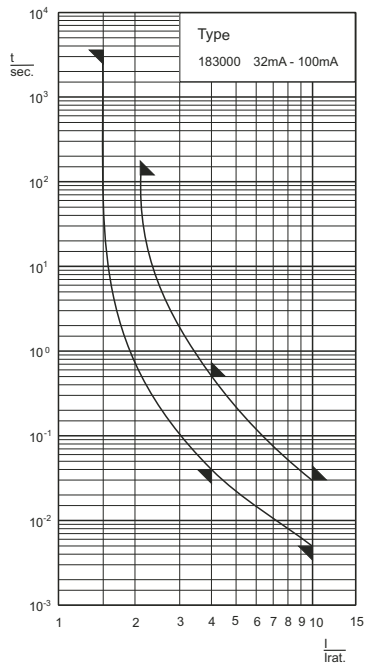

Abmessungen
Dimensions

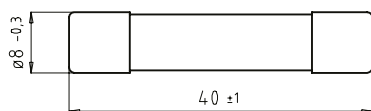

Aufbau / Construction

Glasrohr (bis 100 mA) / glass tube (up to 100 mA)
Keramikrohr (ab 100 mA) / ceramic tube (from 100 mA)
Kontaktkappen / end caps

durchsichtig / transparent
undurchsichtig / non-transparent
Messing, vernickelt / brass, nickel-plated

Schmelzeitgrenzwerte / Fusing time limits

Bemessungsstrom Rated Current	1,5 I _n		2,1 I _n		4 I _n		10 I _n	
	min.	max.	min.	max.	min.	max.	min.	max.
32 mA - 100 mA	1 h	-	-	2 min	40 ms	500 ms	5 ms	30 ms
125 mA - 1 A	1 h	-	-	30 min	-	400 ms	-	30 ms
1,25 A - 6,3 A	1 h	-	-	30 min	-	300 ms	-	20 ms

DIN 41686	8 x 40 mm	500 V	M mittelträge / med. time-lag F flink / quick acting
-----------	------------------	-------	---

Artikel-Nr. Article-no.	Bemessungs- strom Rated Current	Bemessungs- Ausschaltvermögen Rated Breaking Capacity	Span- nungs- fall Voltage Drop	Leistungs- abgabe Power Dissipation	Schmelz- integral I ² t ₉₀ Value	Charakteristik Characteristic	Approbationen Approvals
			mV max.	mW	A ² s		
183000.0,032	32 mA	80 A @ AC 500 V	2300	1)	1)	M	
183000.0,05	50 mA	80 A @ AC 500 V	1600	1)	1)	M	
183000.0,063	63 mA	80 A @ AC 500 V	1300	1)	1)	M	
183000.0,08	80 mA	80 A @ AC 500 V	950	1)	1)	M	
183000.0,1	100 mA	80 A @ AC 500 V	700	1)	1)	M	
183000.0,125	125 mA	1500 A @ AC 500 V	6300	1)	1)	F	
183000.0,16	160 mA	1500 A @ AC 500 V	4700	1)	1)	F	
183000.0,2	200 mA	1500 A @ AC 500 V	3600	1)	1)	F	
183000.0,25	250 mA	1500 A @ AC 500 V	2800	1)	1)	F	
183000.0,315	315 mA	1500 A @ AC 500 V	2100	1)	1)	F	
183000.0,4	400 mA	1500 A @ AC 500 V	1600	1)	1)	F	
183000.0,5	500 mA	1500 A @ AC 500 V	1250	1)	1)	F	
183000.0,63	630 mA	1500 A @ AC 500 V	1000	1)	1)	F	
183000.0,8	800 mA	1500 A @ AC 500 V	800	1)	1)	F	
183000.1	1 A	1500 A @ AC 500 V	620	1)	1)	F	
183000.1,25	1,25 A	1500 A @ AC 500 V	520	1)	1)	F	
183000.1,6	1,6 A	1500 A @ AC 500 V	450	1)	1)	F	
183000.2	2 A	1500 A @ AC 500 V	400	1)	1)	F	
183000.2,5	2,5 A	1500 A @ AC 500 V	370	1)	1)	F	
183000.3,15	3,15 A	1500 A @ AC 500 V	340	1)	1)	F	
183000.4	4 A	1500 A @ AC 500 V	320	1)	1)	F	
183000.5	5 A	1500 A @ AC 500 V	310	1)	1)	F	
183000.6,3	6,3 A	1500 A @ AC 500 V	300	1)	1)	F	

1) auf Anfrage / On request

Type	Abk. Abbr.	Beschreibung Description
		- 25 Stück / Pieces

Neu / New

Type
7018509



Zeit/Strom-Kennlinien
Time-Current Characteristics

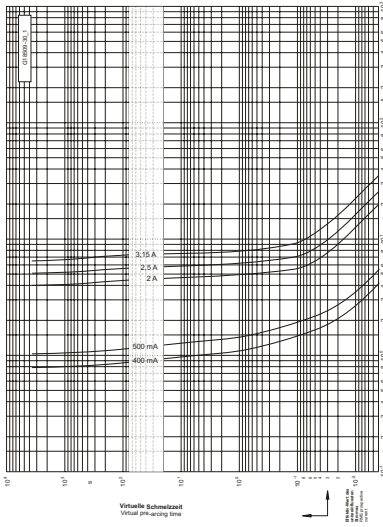

Aufbau / Construction

Keramikrohr / ceramic tube undurchsichtig / non-transparent
Kontaktkappen / end caps Kupferlegierung, vernickelt / Copper alloy, nickel-plated

Schmelzeitgrenzwerte / Fusing time limits

Bemessungsstrom Rated Current	1,5 I _n		2,1 I _n		4 I _n		10 I _n	
	min.	max.	min.	max.	min.	max.	min.	max.
32 mA - 100 mA	1 h	-	-	2 min	40 ms	500 ms	5 ms	30 ms
125 mA - 1 A	1 h	-	-	30 min	-	400 ms	-	30 ms

Sondertyp Special type	8 x 65 mm	1,5 kV	F flink / quick acting
---------------------------	------------------	--------	------------------------

Abmessungen
Dimensions

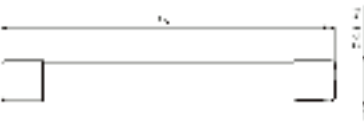

Artikel-Nr. Article-no.	Bemessungs- strom Rated Current	Bemessungs- Ausschaltvermögen Rated Breaking Capacity	Spannungs- fall Voltage Drop	Leistungs- abgabe Power Dissipation	Schmelzintegral Pre-arcing I ² t _s Value (@ 10 x I _n)	Approbationen Approvals
			mV max.	mW	A ² s	
7018509,0,4	400 mA	30 kA @ DC 1500 V	780	1)	0,06	
7018509,0,5	500 mA	30 kA @ DC 1500 V	700	1)	0,12	
7018509,2	2 A	30 kA @ DC 1500 V	690	1)	1,6	
7018509,2,5	2,5 A	30 kA @ DC 1500 V	690	1)	2,6	
7018509,3,15	3,15 A	30 kA @ DC 1500 V	690	1)	4,9	

1) auf Anfrage / On request

Type	Abk. Abbr.	Beschreibung Description
		- 25 Stück / Pieces

Type 184000

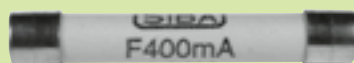

Type 185000

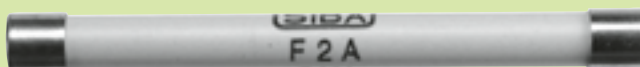

Zeit/Strom-Kennlinien
Time-Current Characteristics

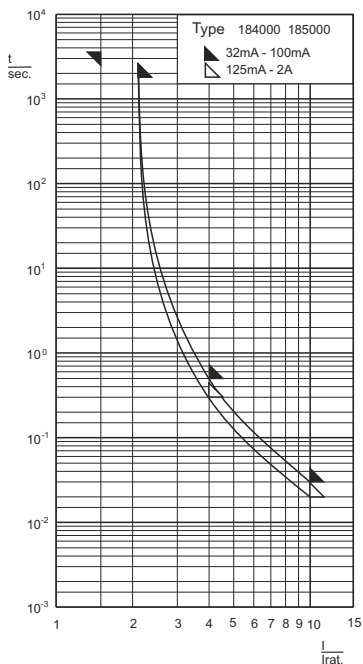

Aufbau / Construction

Keramikrohr / ceramic tube ²⁾

undurchsichtig / non-transparent

Kontaktkappen / end caps

Messing, vernickelt / brass, nickel-plated

Zubehör / Related Products

Halter / holder

siehe Seite 89 / see page 89

Schmelzeitgrenzwerte / Fusing time limits

Bemessungsstrom Rated Current	1,5 I _n		2,1 I _n		4 I _n		10 I _n	
	min.	max.	min.	max.	min.	max.	min.	max.
32 mA - 100 mA	1 h	-	-	30 min	-	500 ms	-	30 ms
125 mA - 6,3 A (Type 184000)	1 h	-	-	30 min	-	300 ms	-	20 ms
125 mA - 4 A (Type 185000)	1 h	-	-	30 min	-	300 ms	-	20 ms

DIN 41570 DIN 41569	8 x 50 mm 8 x 85 mm	1,2 kV 3 kV	M mittelträge / med. time-lag F flink / quick acting
------------------------	--------------------------------------	----------------	---

Abmessungen
Dimensions

184000

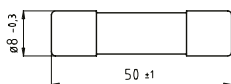

185000

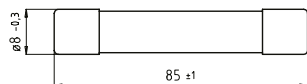

Artikel-Nr. Article-no.	Artikel-Nr. Article-no.	Bemessungs- strom Rated Current	Bemessungs- Ausschaltvermögen Rated Breaking Capacity	Spannungsfall 184000 Voltage Drop	Spannungsfall 185000 Voltage Drop	Charakte- ristik Characte- ristic
				mV max.	mV max.	
8 x 50 mm	8 x 85 mm					
184000.0,032	185000.0,032	32 mA	¹⁾	2300	4500	M
184000.0,05	185000.0,05	50 mA	¹⁾	1900	3000	M
184000.0,063	185000.0,063	63 mA	¹⁾	1700	2400	M
184000.0,08	185000.0,08	80 mA	¹⁾	1500	1900	M
184000.0,1	185000.0,1	100 mA	¹⁾	1300	1500	M
184000.0,125	185000.0,125	125 mA	¹⁾	9500	17000	F
184000.0,16	185000.0,16	160 mA	¹⁾	8000	14000	F
184000.0,2	185000.0,2	200 mA	¹⁾	7000	12000	F
184000.0,25	185000.0,25	250 mA	¹⁾	6000	10500	F
184000.0,315	185000.0,315	315 mA	¹⁾	5000	9000	F
184000.0,4	185000.0,4	400 mA	¹⁾	2000	3500	F
184000.0,5	185000.0,5	500 mA	¹⁾	950	1600	F
184000.0,63	185000.0,63	630 mA	¹⁾	860	1500	F
184000.0,8	185000.0,8	800 mA	¹⁾	760	1300	F
184000.1	185000.1	1 A	¹⁾	640	1200	F
184000.1,25	185000.1,25	1,25 A	¹⁾	540	1000	F
184000.1,6	185000.1,6	1,6 A	¹⁾	500	900	F
184000.2	185000.2	2 A	¹⁾	460	800	F
184000.2,5	185000.2,5	2,5 A ²⁾	¹⁾	³⁾	³⁾	F
184000.3,15	185000.3,15	3,15 A ²⁾	¹⁾	³⁾	³⁾	F
184000.4	185000.4	4 A ²⁾	¹⁾	³⁾	³⁾	F
184000.5	-	5 A ²⁾	¹⁾	³⁾		F
184000.6,3	-	6,3 A ²⁾	¹⁾	³⁾		F

¹⁾ 184000: 35 A @ AC 1,2 kV;
185000: 35 A @ AC 3 kV

²⁾ zusätzlich lieferbare Bemessungsströme / Non-standard ratings also available

³⁾ auf Anfrage / On request

Type	Abk. Abbr.	Beschreibung Description
	-	25 Stück / Pieces

Type
186000

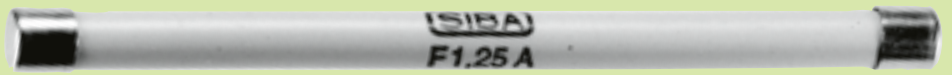

Type
187000



Zeit/Strom-Kennlinien
Time-Current Characteristics

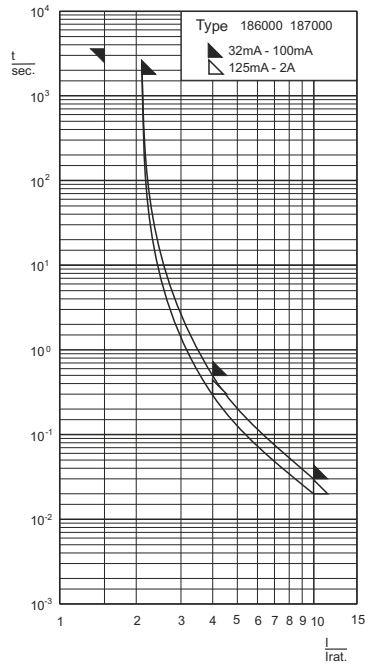

Aufbau / Construction

Keramikrohr / ceramic tube

undurchsichtig / non-transparent

Kontaktkappen / end caps

Messing, vernickelt / brass, nickel-plated

Zubehör / Related Products

Halter / holder

siehe Seite 89 / see page 89

Schmelzeitgrenzwerte / Fusing time limits

Bemessungsstrom Rated Current	1,5 I _n		2,1 I _n		4 I _n		10 I _n	
	min.	max.	min.	max.	min.	max.	min.	max.
32 mA - 100 mA	1 h	-	-	30 min	-	500 ms	-	30 ms
125 mA - 4 A (Type 186000)	1 h	-	-	30 min	-	300 ms	-	20 ms
125 mA - 2 A (Type 187000)	1 h	-	-	30 min	-	300 ms	-	20 ms

DIN 41683 DIN 41684	8 x 120 mm 8 x 150 mm	6 kV 10 kV	M mittelträge / med. time-lag F flink / quick acting
------------------------	--	---------------	---

Abmessungen
Dimensions

186000

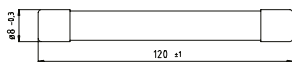

187000

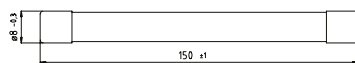

Artikel-Nr. Article-no.	Artikel-Nr. Article-no.	Bemessungs- strom Rated Current	Bemessungs- Ausschaltvermögen Rated Breaking Capacity	Spannungsfall 186000 Voltage Drop	Spannungs- fall 187000 Voltage Drop	Charakte- ristik Characte- ristics
				mV max.	mV max.	
	8 x 120 mm	8 x 150 mm				
186000.0,032	187000.0,032	32 mA		6000	14000	M
186000.0,05	187000.0,05	50 mA		4400	8500	M
186000.0,063	187000.0,063	63 mA		3800	6500	M
186000.0,08	187000.0,08	80 mA		3200	5000	M
186000.0,1	187000.0,1	100 mA		2900	4000	M
186000.0,125	187000.0,125	125 mA		22000	27000	F
186000.0,16	187000.0,16	160 mA		19000	24000	F
186000.0,2	187000.0,2	200 mA		16000	21000	F
186000.0,25	187000.0,25	250 mA		14000	18500	F
186000.0,315	187000.0,315	315 mA		12000	17000	F
186000.0,4	187000.0,4	400 mA		5000	6000	F
186000.0,5	187000.0,5	500 mA		2300	2900	F
186000.0,63	187000.0,63	630 mA		2000	2700	F
186000.0,8	187000.0,8	800 mA		1900	2400	F
186000.1	187000.1	1 A		1800	2100	F
186000.1,25	187000.1,25	1,25 A		1400	1800	F
186000.1,6	187000.1,6	1,6 A		1300	1600	F
186000.2	187000.2	2 A		1100	1400	F
186000.2,5	-	2,5 A ²⁾		³⁾	-	F
186000.3,15	-	3,15 A ²⁾		³⁾	-	F
186000.4	-	4 A ²⁾		³⁾	-	F

¹⁾ 186000: 35 A @ AC 6 kV

187000: 35 A @ AC 10 kV

²⁾ zusätzlich lieferbare Bemessungsströme / Non-standard ratings also available

³⁾ auf Anfrage / On request

Type	Abk. Abbr.	Beschreibung Description
	-	25 Stück / Pieces



Weitere G-Hochspannungstypen / G-high voltage fuses

Artikel-Nr.	Abmessung	Bemessungsspannung	Bemessungsstrom	Charakteristik
Article-no.	Dimension	Rated Voltage	Rated current	Characteristics
7011509	10x85 mm	AC 3 kV	0,125 - 4 A	F
7011527	10x85 mm	AC 1,5 kV / DC 1 kV	0,63 - 12,5 A	T
7011552	10x85 mm	AC 1,5 kV / DC 1 kV	1 - 20 A	F
7012927	11x79 mm	AC 1 kV	2 - 16 A	T
7012952	11x79 mm	AC 1 kV	1 - 10 A	F
7017182	10x85 mm	AC 1 kV	2 - 16 A	aM
7002924	12x100 mm	AC 3 kV	0,5 - 10 A	F
7002927	12x100 mm	AC 3 kV	2,5 - 6,3 A	T
7003024	12x150 mm	AC 6 kV	0,5 - 4	F
7003124	12x200 mm	AC 10 kV	0,5 - 2	F

Datenblätter auf Anfrage - Data sheets on request

G-Sicherungshalter / Fuse-Holder

G-Sicherungshalter für Kleinstsicherungen /
Fuse-Holders for Sub-miniature Fuses
G-Sicherungshalter für G-Sicherungseinsätze /
Fuse-Holders for miniature Fuse-Links
G-Sicherungshalter für Hochspannungs-
Sicherungseinsätze /
Fuse-Holders for High-Voltage
miniature Fuse-Links



Type
166602

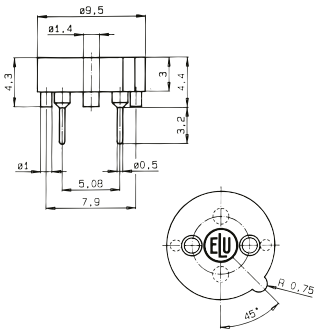

**G-Sicherungshalter für Kleinstsicherungen 8,4 x 7,6 mm /
Fuse-Holders for Sub-miniature Fuses 8.4 x 7.6 mm**

für Kleinstsicherungen mit kurzen Anschlussstiften / for sub-miniature fuses with short pins

Bemessungsstrom / rated current	6,3 A
Montage / mounting	Leiterplatte / printed circuit board
Stiftabstand / pin distance	5,08 mm
Bohrungen / hole	Ø 1 mm
Anschlüsse / connections	lötbar / solderable

Type
199073

5 mm

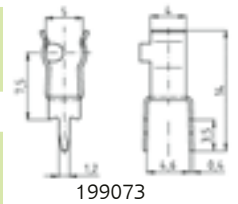

Type
199207

5 mm

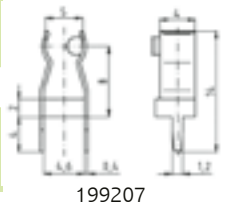

Type
199487

5 mm

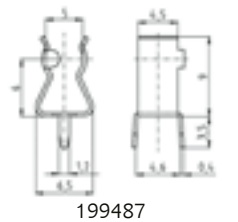

Type
199429

6,3 mm



**G-Sicherungshalter für G-Sicherungseinsätze mit 5 + 6,3 mm Kappen-Ø /
Fuse-clips for miniature Fuse-Links with 5 + 6.3 mm cap Ø**

Bemessungsstrom / rated current	6,3 A Ø 5 mm
	10 A Ø 6,3 mm

Montage / mounting	Leiterplatte / printed circuit board
Material / material	Messing, verzinkt / brass, tinned
Anschlüsse / connections	lötbar / solderable

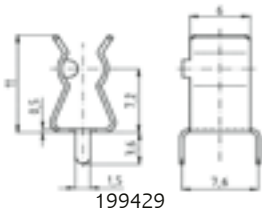

199429

Type
199015

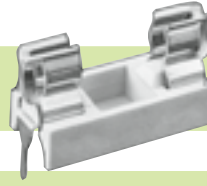

Type
199015A

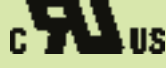

Type
199016

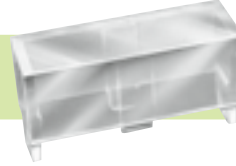

199015

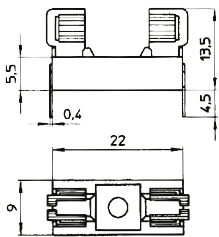

G-Sicherungshalter für G-Sicherungseinsätze 5 x 20 mm / Fuse-Holder (Fuse-Blocks) for miniature Fuse-Links 5 x 20 mm

Bemessungsspannung / rated voltage 250 V
Bemessungsstrom / rated current 6,3 A (VDE), 10A (UL)
Bemessungsleistung / rated power 1,6 W

Montage / mounting Leiterplatte / printed circuit board
Stiftabstand / pin distance 22,5 mm
Bohrungen / hole Ø 1,5 mm
Anschlüsse / connections lötfar / solderable

Abdeckung / cover 199016
Thermoplast, transparent / thermoplastic, transparent

199015A

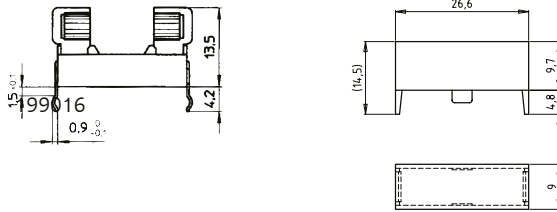

Type
199060

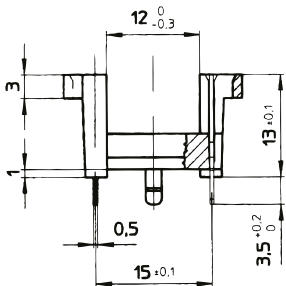

G-Sicherungshalter für G-Sicherungseinsätze 5 x 20 mm / Fuse-Holder (Fuse-Blocks) for miniature Fuse-Links 5 x 20 mm

Bemessungsspannung / rated voltage 250 V
Bemessungsstrom / rated current 6,3 A
Bemessungsleistung / rated power 1,6 W

Montage / mounting Leiterplatte / printed circuit board
Stiftabstand / pin distance 15 mm
Bohrungen / hole Ø 1,3/2,6 mm
Anschlüsse / connections lötfar / solderable

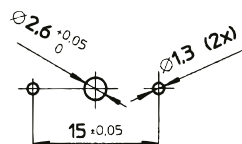
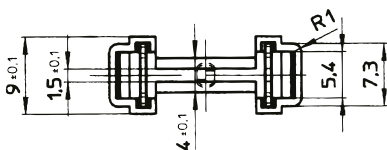

Type
199030

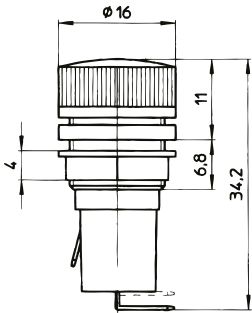

**G-Sicherungshalter für G-Sicherungseinsätze 5 x 20 mm /
Fuse-Holders for miniature Fuse-Links 5 x 20 mm**

Bemessungsspannung / rated voltage	250 V
Bemessungsstrom / rated current	10 A
Bemessungsleistung / rated power	2,5 W
Spannungsfestigkeit / dielectric strength	3 kV
Schutzart / protection standard	IP 40
Berührungsschutzkategorie / shocksafe category	PC2

Montage / mounting	Frontplatte / panel
Loch / hole	Ø 13 mm
Verdrehungsschutz / locating lug	
Gegenmutter / locknut	SW14
Verschlusskappe / fuse-carrier	Schraubverschluss / screw cap
Anschlüsse / connections	löt- und steckbar / solderable and pluggable (Steckhülse 2,8mm) / (plug connector 2,8mm)
Approbationen / approvals	VDE, UL recognized

Type
199035

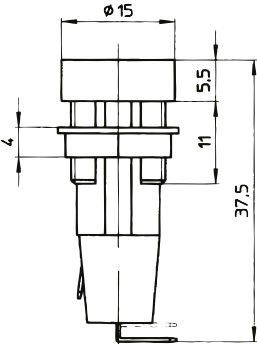

**G-Sicherungshalter für G-Sicherungseinsätze 5 x 20 mm /
Fuse-Holders for miniature Fuse-Links 5 x 20 mm**

Bemessungsspannung / rated voltage	250 V
Bemessungsstrom / rated current	10 A
Bemessungsleistung / rated power	2,5 W
Spannungsfestigkeit / dielectric strength	3 kV
Schutzart / protection standard	IP 40
Berührungsschutzkategorie / shocksafe category	PC2

Montage / mounting	Frontplatte / panel
Loch / hole	Ø 12,7 mm
Verdrehungsschutz / with flat as shown	
Gegenmutter / locknut	SW14
Verschlusskappe / fuse-carrier	Schraubverschluss / screw cap
Anschlüsse / connections	löt- und steckbar / solderable and pluggable (Steckhülse 2,8mm) / (plug connector 2,8mm)
Approbationen / approvals	VDE, UL recognized

Type
199045

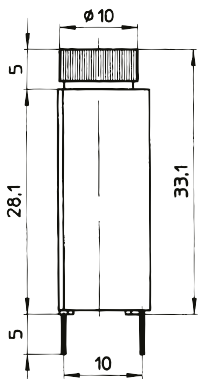

**G-Sicherungshalter für G-Sicherungseinsätze 5 x 20 mm /
Fuse-Holders for miniature Fuse-Links 5 x 20 mm**

Bemessungsspannung / rated voltage	250 V
Bemessungsstrom / rated current	10 A
Bemessungsleistung / rated power	2,5 W
Spannungsfestigkeit / dielectric strength	3 kV
Schutzart / protection standard	IP 40
Berührungsschutzkategorie / shocksafe category	PC2

Montage / mounting	Leiterplatte / printed circuit board
Stiftabstand / pin distance	10 mm
Bohrungen / hole	Ø 1,3 +0,1 mm
Stehende Ausführung / vertical mounting	
Verschlusskappe / fuse-carrier	Renkverschluss / bayonet cap
Anschlüsse / connections	lötbar / solderable
Approbationen / approvals	VDE, UL recognized

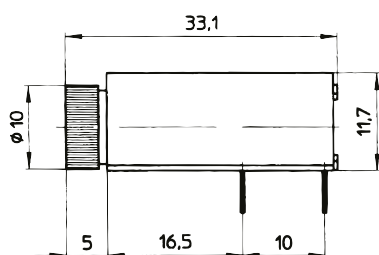
Type
199050

**G-Sicherungshalter für G-Sicherungseinsätze 5 x 20 mm /
 Fuse-Holders for miniature Fuse-Links 5 x 20 mm**

Bemessungsspannung / rated voltage	250 V
Bemessungsstrom / rated current	10 A
Bemessungsleistung / rated power	2,5 W
Spannungsfestigkeit / dielectric strength	3 kV
Schutzart / protection standard	IP 40
Berührungsschutzkategorie / shocksafe category	PC2

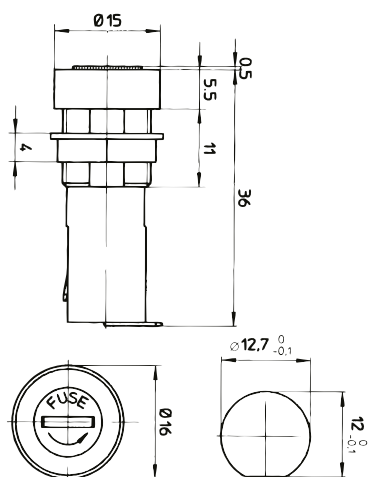
Montage / mounting	Leiterplatte / printed circuit board
Stiftabstand / pin distance	10 mm
Bohrungen / hole	Ø 1,3 +0,1 mm
Liegende Ausführung / horizontal mounting	
Verschlusskappe / fuse-carrier	Renkverschluss / bayonet cap
Anschlüsse / connections	lötbar / solderable
Approbationen / approvals	VDE, UL recognized

 Type
199055

**G-Sicherungshalter für G-Sicherungseinsätze 5 x 20 mm /
 Fuse-Holders for miniature Fuse-Links 5 x 20 mm**

Bemessungsspannung / rated voltage	250 V
Bemessungsstrom / rated current	10 A
Bemessungsleistung / rated power	2,5 W
Spannungsfestigkeit / dielectric strength	3 kV
Schutzart / protection standard	IP 40
Berührungsschutzkategorie / shocksafe category	PC2

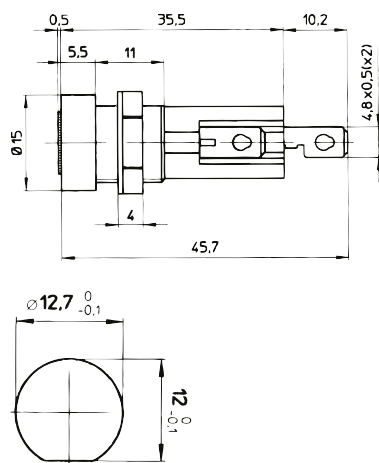
Montage / mounting	Frontplatte / panel
Loch / hole	Ø 12,7 mm
Verdrehungsschutz / with flat as shown	
Gegenmutter / locknut	SW14
Verschlusskappe / fuse-carrier	Renkverschluss / bayonet cap
Anschlüsse / connections	lötbar / solderable
Approbationen / approvals	VDE, UL recognized

 Type
199070

**G-Sicherungshalter für G-Sicherungseinsätze 5 x 20 mm /
 Fuse-Holders for miniature Fuse-Links 5 x 20 mm**

Bemessungsspannung / rated voltage	250 V
Bemessungsstrom / rated current	6,3A (VDE) / 10 A (UL/CSA)
Bemessungsleistung / rated power	2,5 W
Spannungsfestigkeit / dielectric strength	3 kV
Schutzart / protection standard	IP 40
Berührungsschutzkategorie / shocksafe category	PC2

Montage / mounting	Frontplatte / panel
Loch / hole	Ø 12,7 mm
Verdrehungsschutz / with flat as shown	
Gegenmutter / locknut	SW14
Verschlusskappe / fuse-carrier	Renkverschluss / bayonet cap
Anschlüsse / connections	löt- oder steckbar / solderable or pluggable (Steckhülse / plug connector 4,8 mm)
Approbationen / approvals	VDE, UL recognized

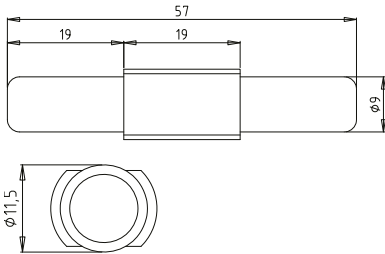
Type
199080



**G-Sicherungshalter für G-Sicherungseinsätze 5 x 20 mm und 6,3 x 32 mm /
Fuse-Holders for miniature Fuse-Links 5 x 20 mm and 6,3 x 32 mm**

Bemessungsspannung / rated voltage 250 V
Bemessungsstrom / rated current 6,3 A
Bemessungsleistung / rated power 1,6 W

Montage / mounting

Verschluss / locking
Anschlüsse / connections

Leitungszugsicherungshalter, Kabelverbinder /
in-line fuse-holder

Renkverschluss / bayonet type
lötbar / solderable

Type
199080A

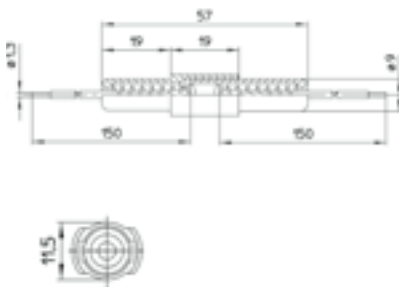

**G-Sicherungshalter für G-Sicherungseinsätze 5 x 20 mm und 6,3 x 32 mm /
Fuse-Holders for miniature Fuse-Links 5 x 20 mm and 6,3 x 32 mm**

Bemessungsspannung / rated voltage 250 V
Bemessungsstrom / rated current 6,3 A
Bemessungsleistung / rated power 1,6 W

Montage / mounting

Verschluss / locking
Anschlüsse / connections

Leitungszugsicherungshalter, Kabelverbinder /
in-line fuse-holder

Renkverschluss / bayonet type
lötbar / solderable

Type
199090

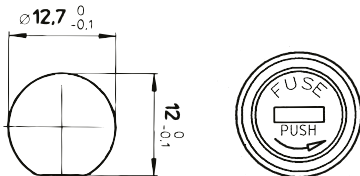
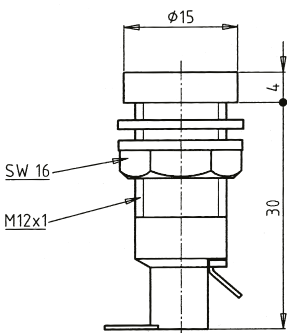

**G-Sicherungshalter für G-Sicherungseinsätze 5 x 20 mm /
Fuse-Holders for miniature Fuse-Links 5 x 20 mm**

Bemessungsspannung / rated voltage 250 V
Bemessungsstrom / rated current 6,3 / 10 A
Spannungsfestigkeit / dielectric strength 3 kV
Schutzart / protection standard IP 40

Montage / mounting
Loch / hole
Verdrehungsschutz / with flat as shown
Gegenmutter / locknut

Verschlusskappe / fuse-carrier
Anschlüsse / connections

Approbationen / approvals

Frontplatte / panel
Ø 12,7 mm

SW16

Renkverschluss / bayonet cap
lötbar / solderable

VDE SEMKO (6,3 A), UL CSA (10 A)

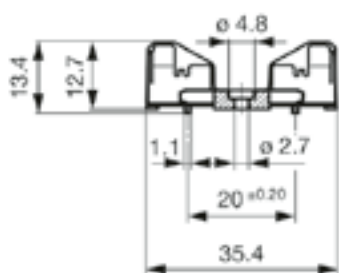
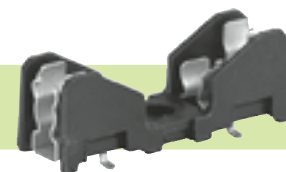

Type
199511

SMD-Sicherungshalter für G-Sicherungseinsätze 5 x 20 mm oder 6,3 x 32 mm / Fuse-Holders (Fuse-Blocks) for miniature Fuse-Links 5 x 20 mm or 6,3 x 32 mm

Bemessungsspannung / rated voltage	AC 500 V (VDE), AC/DC 600V (UL/CSA)
Bemessungsstrom / rated current	10 A (VDE) / 16 A (UL/CSA)
Bemessungsleistung / rated power	4 W @ 10 A
Spannungsfestigkeit / dielectric strength	3 kV

Montage / mounting	Leiterplatte / printed circuit board
Befestigung / fixing	Schraube oder Niet / screw or rivet

Anschlüsse / connections	lötbar / solderable
--------------------------	---------------------

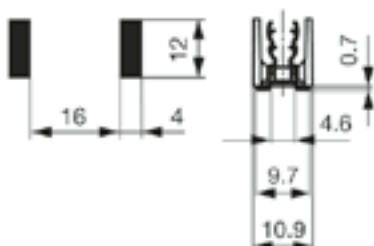
Approbationen / approvals	VDE, UL recognized
---------------------------	--------------------

Empfohlene Anschlussflächen:
 Recommended pad layout:

Type
199530

Type
199531

199530

G-Sicherungshalter für G-Sicherungseinsätze 6,3 x 32 mm / Fuse-Holders for miniature Fuse-Links 6,3 x 32 mm

Bemessungsspannung / rated voltage	AC 500 V (VDE), AC/DC 600 V (UL/CSA)
Bemessungsstrom / rated current	10 A (VDE), 20 A (UL/CSA)
Bemessungsleistung / rated power	4 W @ 10 A
Spannungsfestigkeit / dielectric strength	3 kV
Schutzart / protection standard	IP 40
Berührungsschutzkategorie / shocksafe category	PC2

Montage / mounting	Frontplatte / front-panel
Loch / hole	Ø 16,5 mm

Verschlusskappe / fuse-carrier	Renkverschluss / bayonet cap
Anschlüsse / connections	Steck / Quick-connect 6,3x8mm

Approbationen / approvals	VDE, UL recognized
---------------------------	--------------------

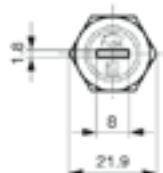
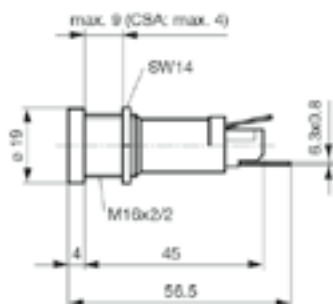
Durchbrüche der Montageplatte:
 Mounting holes:

Type
199537

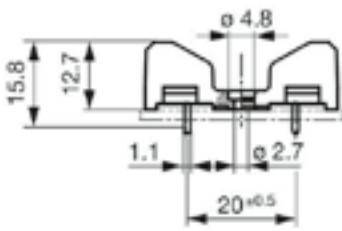

Bohrplan:
Drilling holes:

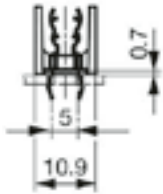
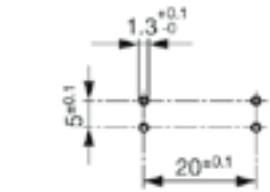

G-Sicherungshalter für G-Sicherungseinsätze 5 x 20 mm oder 6,3 x 32 mm / Fuse-Holder (Fuse-Blocks) for miniature Fuse-Links 5 x 20 mm or 6,3 x 32 mm

Bemessungsspannung / rated voltage AC 500 V (VDE), AC/DC 600 V (UL/CSA)
 Bemessungsstrom / rated current 10 A (VDE) / 16 A (UL/CSA)
 Bemessungsleistung / rated power 4 W @ 10 A
 Spannungsfestigkeit / dielectric strength 3 kV

Montage / mounting Leiterplatte / printed circuit board
 Befestigung / fixing Schraube oder Niet / screw or rivet
 Bohrungen / hole Ø 1,3 +0,1 mm

Anschlüsse / connections lötlbar THT / solderable THT
 Approbationen / approvals VDE, UL recognized

Type
199550



Type
199552



199550

G-Sicherungshalter für G-Sicherungseinsätze 6,3 x 32 mm / Fuse-Holder for miniature Fuse-Links 6,3 x 32 mm

Bemessungsspannung / rated voltage AC 500 V (VDE), AC/DC 600 V (UL/CSA)
 Bemessungsstrom / rated current 16 A (VDE), 30 A (UL/CSA)
 Bemessungsleistung / rated power 4 W @ 16 A
 Spannungsfestigkeit / dielectric strength 3 kV
 Schutzart / protection standard IP 40
 Berührungsschutzkategorie / shocksafe category PC2

Montage / mounting Leiterplatte / printed circuit board
 Verschlusskappe / fuse-carrier Schraubverschluss / screw cap
 Anschlüsse / connections lötlbar THT / solderable THT
 Approbationen / approvals VDE, UL recognized

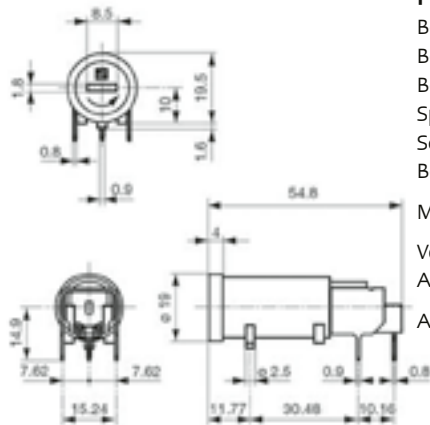

Bohrplan:
Drilling holes:

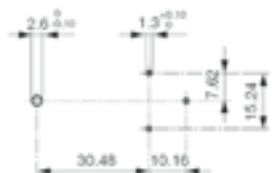

Type
199555



C **UL** US

Type
199552



C **UL** US

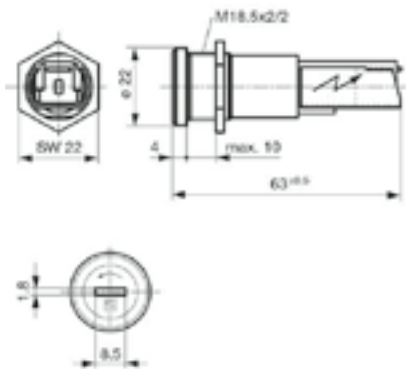

**G-Sicherungshalter für G-Sicherungseinsätze 6,3 x 32 mm /
Fuse-Holders for miniature Fuse-Links 6,3 x 32 mm**

Bemessungsspannung / rated voltage	AC 500 V (VDE), AC 600V (UL/CSA)
Bemessungsstrom / rated current	16 A (VDE) / 30 A (UL/CSA)
Bemessungsleistung / rated power	4 W @ 16 A
Spannungsfestigkeit / dielectric strength	3 kV
Schutzart / protection standard	IP 40
Berührungsschutzkategorie / shocksafe category	PC2
Montage / mounting	Frontplatte / front-panel
Befestigung / fixing	Schraubmutter / fixing nut
Verschlusskappe / fuse-carrier	Schraubverschluss / screw cap
Anschlüsse / connections	Steck / Quick-connect 6,3 x 0,8 mm
Approbationen / approvals	VDE, UL recognized

Type
7100127

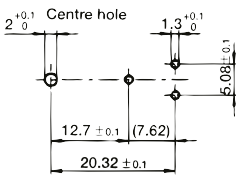
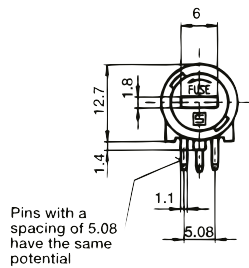
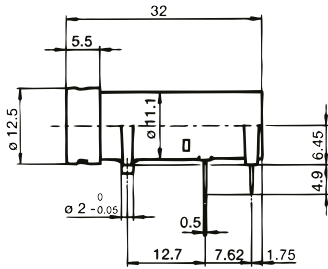
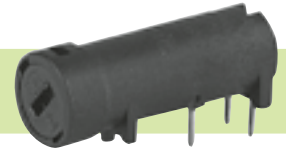

G-Sicherungshalter für G-Sicherungseinsätze 5 x 20 mm / Fuse-Holder for miniature Fuse-Links 5 x 20 mm

Bemessungsspannung / rated voltage AC / 250 V
 Bemessungsstrom / rated current 10 A (VDE) / 16 A (UL/CSA)
 Bemessungsleistung / rated power 2,5 W @ 10 A
 Spannungsfestigkeit / dielectric strength 3 kV
 Schutzart / protection standard IP 40
 Berührungsschutzkategorie / shocksafe category PC2

Montage / mounting Leiterplatte / printed circuit board
 Stiftabstand / pin distance 7,62 mm
 Bohrungen / holes Ø 1,3 mm + 0,1 mm
 Verschlusskappe / fuse-carrier Renkverschluss / bayonet cap
 Anschlüsse / connections lötfar / solderable
 Approbationen / approvals VDE, UL rec.

Type
7100128

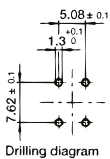
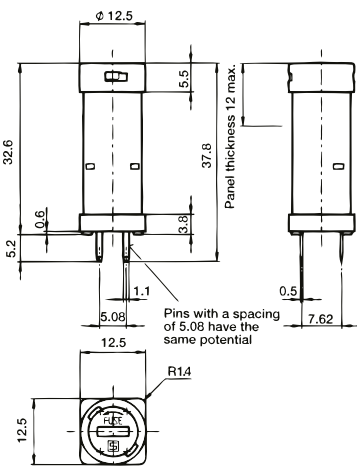

G-Sicherungshalter für G-Sicherungseinsätze 5 x 20 mm / Fuse-Holder for miniature Fuse-Links 5 x 20 mm

Bemessungsspannung / rated voltage AC / 250 V
 Bemessungsstrom / rated current 10 A (VDE) / 16 A (UL/CSA)
 Bemessungsleistung / rated power 2,5 W @ 10 A
 Spannungsfestigkeit / dielectric strength 3 kV
 Schutzart / protection standard IP 40
 Berührungsschutzkategorie / shocksafe category PC2

Montage / mounting Leiterplatte / printed circuit board
 stehende Ausführung / vertical type
 Stiftabstand / pin distance 7,62 mm
 Bohrungen / holes Ø 1,3 + 0,1 mm
 Verschlusskappe / fuse-carrier Renkverschluss / bayonet cap
 Anschlüsse / connections lötfar / solderable
 Approbationen / approvals VDE, ULrec.

Type
7100129

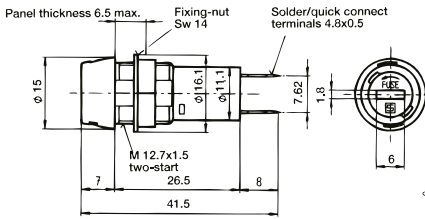

G-Sicherungshalter für G-Sicherungseinsätze 5 x 20 mm / Fuse-Holders for miniature Fuse-Links 5 x 20 mm

Bemessungsspannung / rated voltage	AC 250 V
Bemessungsstrom / rated current	10 A (VDE) / 16 A (UL/CSA)
Bemessungsleistung / rated power	2,5 W @ 10 A
Spannungsfestigkeit / dielectric strength	3kV
o Schutzart / protection standard	IP 40
Berührungsschutzkategorie / shocksafe category	PC2

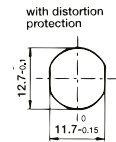
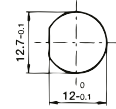
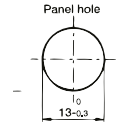

Montage / mounting	Frontplatte / front panel
Loch / hole	Ø 13 mm
Verdrehungsschutz / distortion protection	
Gegenmutter / locknut	M12,7 x 1,5
Verschlusskappe / fuse-carrier	Renkverschluss / bayonet cap
Anschlüsse / connections	lötbar / solderable
Approbationen / approvals	VDE, UL rec.

Type
204000



5 mm Ø - D = 0,65 mm

Type
204001



5 mm Ø - D = 0,8mm

Type
204002



5 mm Ø - D = 1 mm

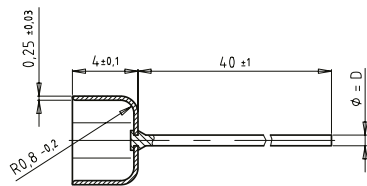

Aufsteckkappen für G-Sicherungseinsätze mit 5 mm Kappen-Ø / Push-on Cap for miniature Fuse-Links with 5 mm cap Ø

Bemessungsstrom / rated current	204000: max. 6,3A
	204001: max. 10A
	204002: max. 16A

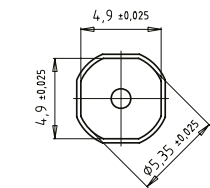

Montage / mounting	Leiterplatte / printed circuit board
Anschlüsse / connections	Axial angeschweisste Drahtenden Drahtenden 40 mm, lötbar / axially welded wire-ends of 40 mm, solderable
Material Kappen / material contact caps	Kupferlegierung vernickelt / copper alloy, nickel plated
Material Drähte / material wire-ends	Kupfer, verzinkt / copper, tinned

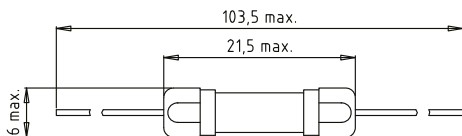

Type
204100



Type
204101

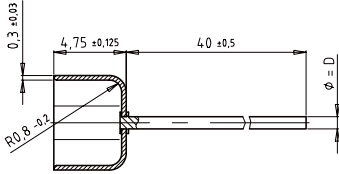

**Aufsteckkappen für G-Sicherungseinsätze mit 6,3 mm Kappen- \varnothing /
Push-on Cap for miniature Fuse-Links with 6.3 mm cap \varnothing**

Bemessungsstrom / rated current

204100: max. 12,5 A

204101: max. 20A

Montage / mounting

Leiterplatte / printed circuit board

Anschlüsse / connections

Axial angeschweisste Drahtenden 40 mm, lötlbar

axially welded wire-ends of 40 mm, solderable

Kupferlegierung vernickelt / copper alloy, nickel plated

Kupfer, verzinkt / copper, tinned

Material Kappen / material contact caps

Material Drähte / material wire-ends

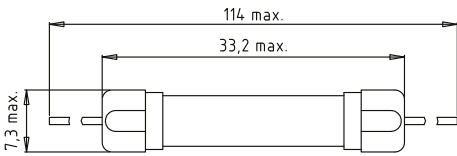
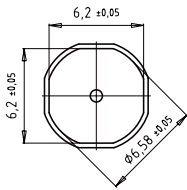

Type
204151



Neu / New

**Aufsteckkappen für G-Sicherungseinsätze mit 6,3 mm Kappen- \varnothing /
Push-on Cap for miniature Fuse-Links with 6.3 mm cap \varnothing**

Bemessungsstrom / rated current

max. 20A

Montage / mounting

Leiterplatte / printed circuit board

Anschlüsse / connections

Axial angeschweisste Drahtenden 58 mm, lötlbar

axially welded wire-ends of 58 mm, solderable

Material Kappen / material contact caps

Kupferlegierung vernickelt / copper alloy, nickel plated

Material Drähte / material wire-ends

Kupfer, verzinkt / copper, tinned

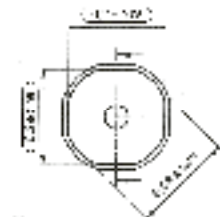
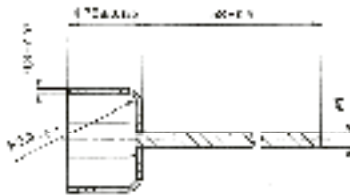

Type
7100123

7100123

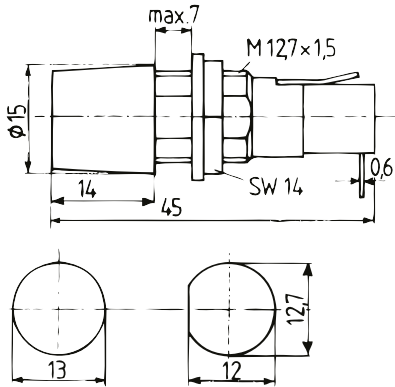
G-Sicherungshalter mit Berührungsschutz (Verschlusskappe siehe unten)
für G-Sicherungseinsätze 5 x 20 mm und 6,3 x 32 mm /
Fuse-Holders with contact protection (Fuse-carrier see below)
for miniature Fuse-Links 5 x 20 mm and 6.3 x 32 mm

Bemessungsspannung / rated voltage	AC 250 V
Bemessungsstrom / rated current	10 A (VDE) / 20 A (UL)
Bemessungsleistung / rated power	4 W @ 10 A

Spannungsfestigkeit / dielectric strength	3 kV
Schutzgrad / protection class	IP 40
Berührungsschutzkategorie / shocksafe category	PC2

Montage / mounting	Frontplatte / panel
Loch \varnothing / hole \varnothing	13 mm

Verdrehungsschutz / distortion protection	
Gegenmutter / locknut	M12,7 x 1,5

Verschlusskappe / fuse-carrier	Renkverschlusskappe / bayonet fixing
--------------------------------	--------------------------------------

Anschlüsse / connections	lötbar / solderable
--------------------------	---------------------

Approbationen / approvals	VDE (10 A), UL rec. (20 A)
---------------------------	----------------------------

Type
7100124

7100124

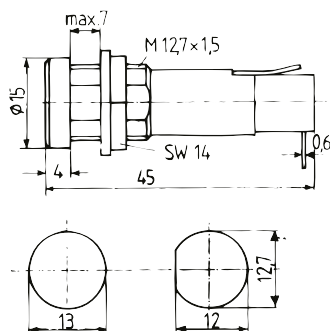
G-Sicherungshalter mit Berührungsschutz (Verschlusskappe s. u.)
für G-Sicherungseinsätze 5 x 20 mm und 6,3 x 32 mm /
Fuse-Holders with contact protection (Fuse-carrier see below)
for miniature Fuse-Links 5 x 20 mm and 6.3 x 32 mm

Bemessungsspannung / rated voltage	250 V
Bemessungsstrom / rated current	10 A (VDE) / 20 A (UL)
Bemessungsleistung / rated power	4 W @ 10 A

Spannungsfestigkeit / dielectric strength	3 kV
Schutzgrad / protection class	IP 40
Berührungsschutzkategorie / shocksafe category	PC2

Montage / mounting	Frontplatte / panel
Loch \varnothing / hole \varnothing	13 mm

Verdrehungsschutz / distortion protection	
Gegenmutter / locknut	M12,7 x 1,5

Anschlüsse / connections	lötbar / solderable
--------------------------	---------------------

Verschlusskappe / fuse-carrier	Renkverschluss / bayonet fixing
--------------------------------	---------------------------------

Approbationen / approvals	VDE, UL rec., CSA
---------------------------	-------------------

Type
7200108

5 x 20 mm



Type
7200109

6,3 x 32 mm



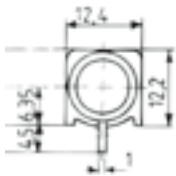
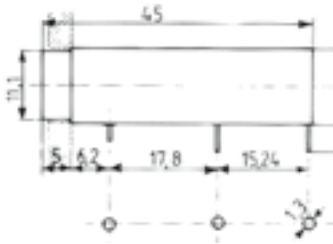

Type
7100114



**G-Sicherungshalter mit Berührungsschutz (Verschlusskappe siehe unten)
für G-Sicherungseinsätze 5 x 20 mm und 6,3 x 32 mm /
Fuse-Holders with contact protection (Fuse-Carrier see below)
for miniature Fuse-Links 5 x 20 mm and 6.3 x 32 mm**

Bemessungsspannung / rated voltage AC 250 V
Bemessungsstrom / rated current 10 A (VDE) / 16 A (UL/CSA)
Bemessungsleistung / rated power 2,5 W (5 x 20 mm) @ 10 A
3,2 W (6,3 x 32 mm) @ 10 A

Spannungsfestigkeit / dielectric strength 3 kV
Schutzgrad / protection class IP 40
Berührungsschutzkategorie / shocksafe category PC2

Montage / mounting Leiterplatte / printed circuit board
Liegende Ausführung / horizontal type

Stiftabstand / pin distance 15,24 mm
Bohrungen / hole Ø 1,3+0,1 mm
Verschlusskappe / fuse-carrier Renkverschlusskappe / bayonet fixing

Anschlüsse / connections lötfar / solderable

Approbationen / approvals VDE, UL rec., CSA

Type
7100116

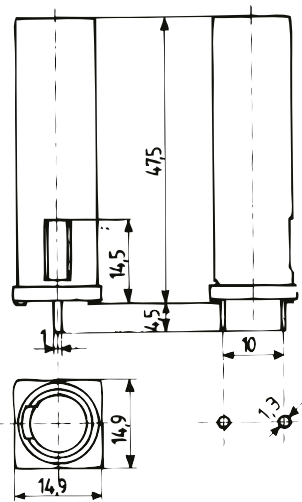

**G-Sicherungshalter mit Berührungsschutz (Verschlusskappe siehe unten)
für G-Sicherungseinsätze 5 x 20 mm und 6,3 x 32 mm /
Fuse-Holders with contact protection (Fuse-Carrier see below)
for miniature Fuse-Links 5 x 20 mm and 6.3 x 32 mm**

Bemessungsspannung / rated voltage 250 V
Bemessungsstrom / rated current 10 A (VDE) / 16 A (UL/CSA)
Bemessungsleistung / rated power 2,5 W (5 x 20 mm)
3,2 W (6,3 x 32 mm)

Spannungsfestigkeit / dielectric strength 3 kV
Schutzgrad / protection class IP 40
Berührungsschutzkategorie / shocksafe category PC2

Montage / mounting Leiterplatte / printed circuit board
Stehende Ausführung / vertical type

Stiftabstand / pin distance 10 mm
Bohrungen / hole Ø 1,3+0,1 mm
Verschlusskappe / fuse-carrier Renkverschlusskappe / bayonet fixing

Anschlüsse / connections lötfar / solderable

Approbationen / approvals VDE, UL rec., CSA



Type
7200108



5 x 20 mm



Type
7200109



6,3 x 32 mm



Type
7103401

75 mm

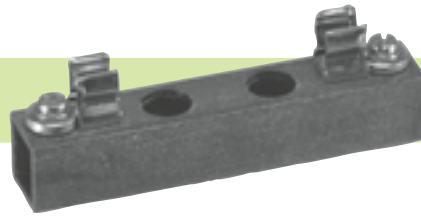

Type
7103701

110 mm

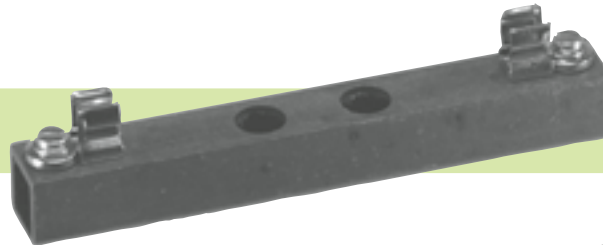

Type
7104001

145 mm

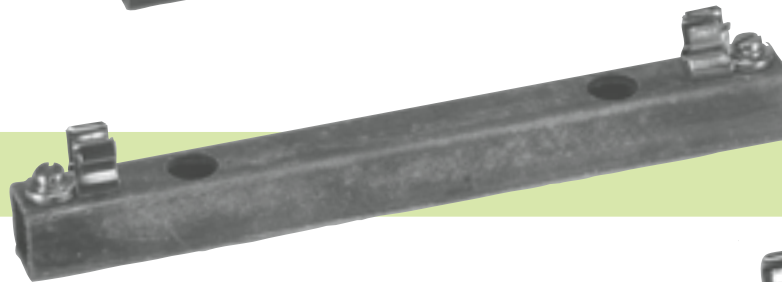

Type
7104301

175 mm

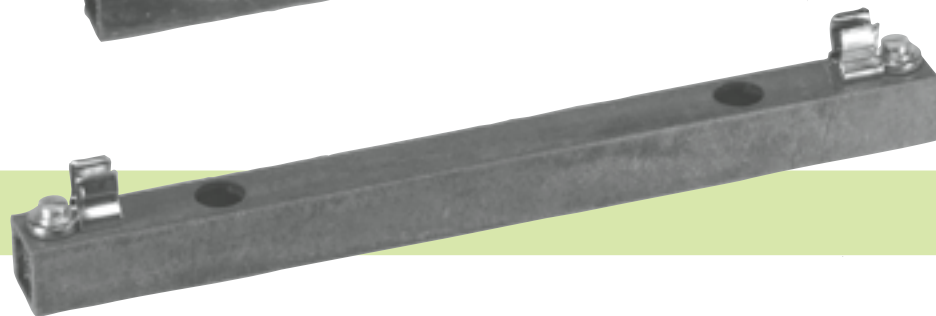

7103401
7103701
7104001
7104301

G-Sicherungshalter offene Bauart für Hochspannungs-G-Sicherungseinsätze / Fuse-Holders open type for High-Voltage miniature Fuse-Links

Montage / mounting

Leiterplatte oder Isolierplatte /
printed circuit board or insulating plate

Anschlüsse / connections

Schraubanschlüsse / screw connections

Approbationen / approvals

-

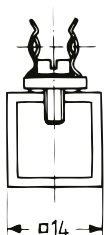
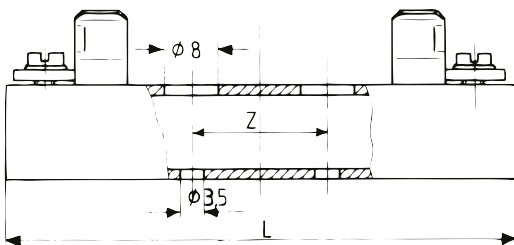

Varianten / Variants

Type	Bemessungs-Spannung Rated Voltage	Bemessungs-strom Rated current	Bemessungs-leistung Rated Power	L	Z	Sicherungseinsatz Fuse-Link	Type	Seite Page
7103401	1,2 kV	6,3 A	4 W	75	20	8 x 50	184000	70
7103701	3 kV	4 A	4 W	110	20	8 x 85	185000	70
7104001	6 kV	4 A	4 W	145	80	8 x 120	186000	71
7104301	10 kV	2 A	4 W	175	100	8 x 150	187000	71

Type
7103702



Type
7102901



Type
7103001

Type
7103101

Weitere Halter für G-Hochspannungssicherungen / Holder for G-high voltage fuses

Artikel-Nr. Article-no.	Bemessungsspannung Rated Voltage	Bemessungsstrom Rated Current	Bemessungsleistung Rated Power	Für Sicherungseinsätze For Fuse-Link	Seite Page
7103702	3 kV	6,3 A	4 W	10 x 85 mm	72
7102901	3 kV	6,3 A	4 W	12 x 100 mm	72
7103001	6 kV	4 A	4 W	12 x 150 mm	72
7103101	10 kV	2 A	4 W	12 x 200 mm	72

Typenvergleichsliste / Cross Reference List

(aktuelle Artikel-Nummern sind fett gedruckt / vaield article nos. are in bold)

ELU → SIBA

ELU	SIBA	Seite Page	ELU	SIBA	Seite Page
157000	7016974	22	184000	7003209	73
158000	7016975	23	184000	7003409	73
160000	7017373	24	185000	7003509	73
164000	7016072	31	185000	7003709	73
164050	7015972	31	186000	7003810	74
164500	7016371	32	186000	7004010	74
164550	7016271	32	187000	7004110	74
165000	7016002	33	187000	7004310	74
165050	7015902	33	189000	7005960	64
166000	7016073	34	189020	7006563	65
166050	7015973	34	189100	7005961	67
166500	7016376	35	189140	7006565	68
166550	7016276	35	189500	7005976	69
166602	7115801	78	190000	7000181	53
171100	7000401	44	195000	7000140	38
171525	7000234	55	195100	7012540	61
171526	7001004	57	199073	7400102	78
171530	7000334	60	199207	7400103	78
172000	7000102	45	204000	7300101	89
172100	7000402	45	204100	7300102	89
172200	7000702	46	7000740	7000740	39
172525	7000202	55	7001205	7001205	59
172525	7000502	55	7001407	7001407	59
172526	7001005	57	7001607	7001607	59
172526	7001105	57	7001707	7001707	59
172530	7000302	60	7008913	7008913	58
172530	7000602	60	157000GT	7017074	22
172900	7500102	54	158000GT	7017075	23
173100	7000403	51	160000GT	7017473	24
179020	7000134	42	164000GT	7016172	31
179021	7000733	43	164500GT	7016471	32
179120	7000135	47	165000GT	7016102	33
179150	7000179	48	166000GT	7016173	34
179200	7000765	49	166500GT	7016476	35
179500	7000176	52			
179900	7500135	54			
179901	7500134	54			
183000	7014311	71			

SIBA → ELU

SIBA	ELU	Seite Page	SIBA	ELU	Seite Page
7000102	172000	45	7006563	189020	65
7000134	179020	42	7006565	189140	68
7000135	179120	47	7008913	7008913	58
7000140	195000	38	7012540	195100	61
7000176	179500	52	7014311	183000	71
7000179	179150	48	7015902	165050	33
7000181	190000	53	7015972	164050	31
7000202	172525	55	7015973	166050	34
7000234	171525	55	7016002	165000	33
7000302	172530	60	7016072	164000	31
7000334	171530	60	7016073	166000	34
7000401	171100	44	7016102	165000GT	33
7000402	172100	45	7016172	164000GT	31
7000403	173100	51	7016173	166000GT	34
7000502	172525	55	7016271	164550	32
7000602	172530	60	7016276	166550	35
7000702	172200	46	7016371	164500	32
7000733	179021	43	7016376	166500	35
7000740	7000740	39	7016471	164500GT	32
7000765	179200	49	7016476	166500GT	35
7001004	171526	56	7016974	157000	22
7001005	172526	57	7016975	158000	23
7001105	172526	56	7017074	157000GT	22
7001205	7001205	59	7017075	158000GT	23
7001407	7001407	59	7017373	160000	24
7001607	7001607	59	7017473	160000GT	24
7001707	7001707	59	7115801	166602	78
7003209	184000	73	7300101	204000	89
7003409	184000	73	7300102	204100	90
7003509	185000	73	7400102	199073	78
7003709	185000	73	7400103	199207	78
7003810	186000	74	7500102	172900	54
7004010	186000	74	7500134	179901	54
7004110	187000	74	7500135	179900	54
7004310	187000	74			
7005960	189000	64			
7005961	189100	67			
7005976	189500	69			

Notizen / Notes

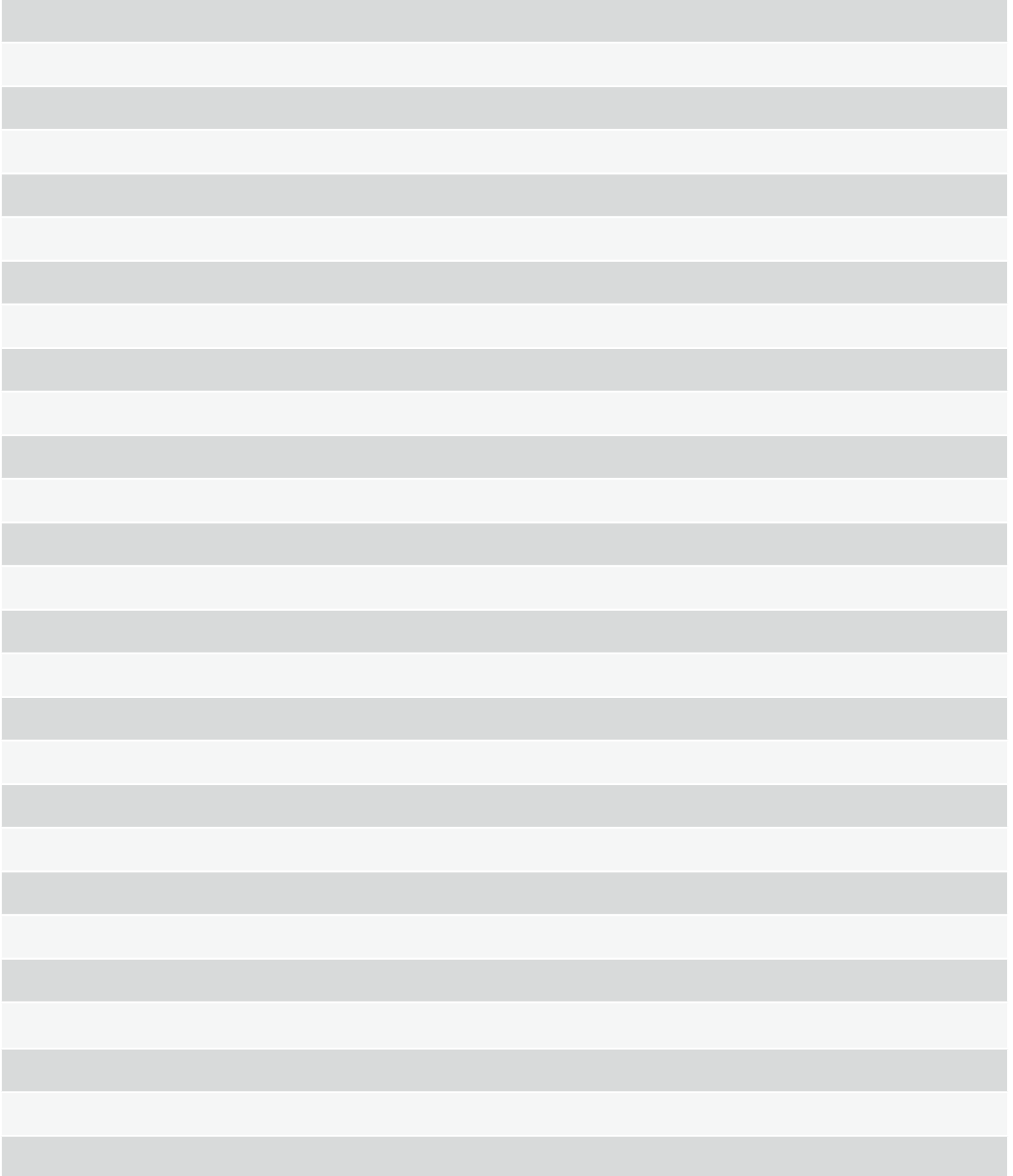

Notizen / Notes

A large rectangular area consisting of alternating light gray and white horizontal stripes, intended for handwritten notes.

Notizen / Notes

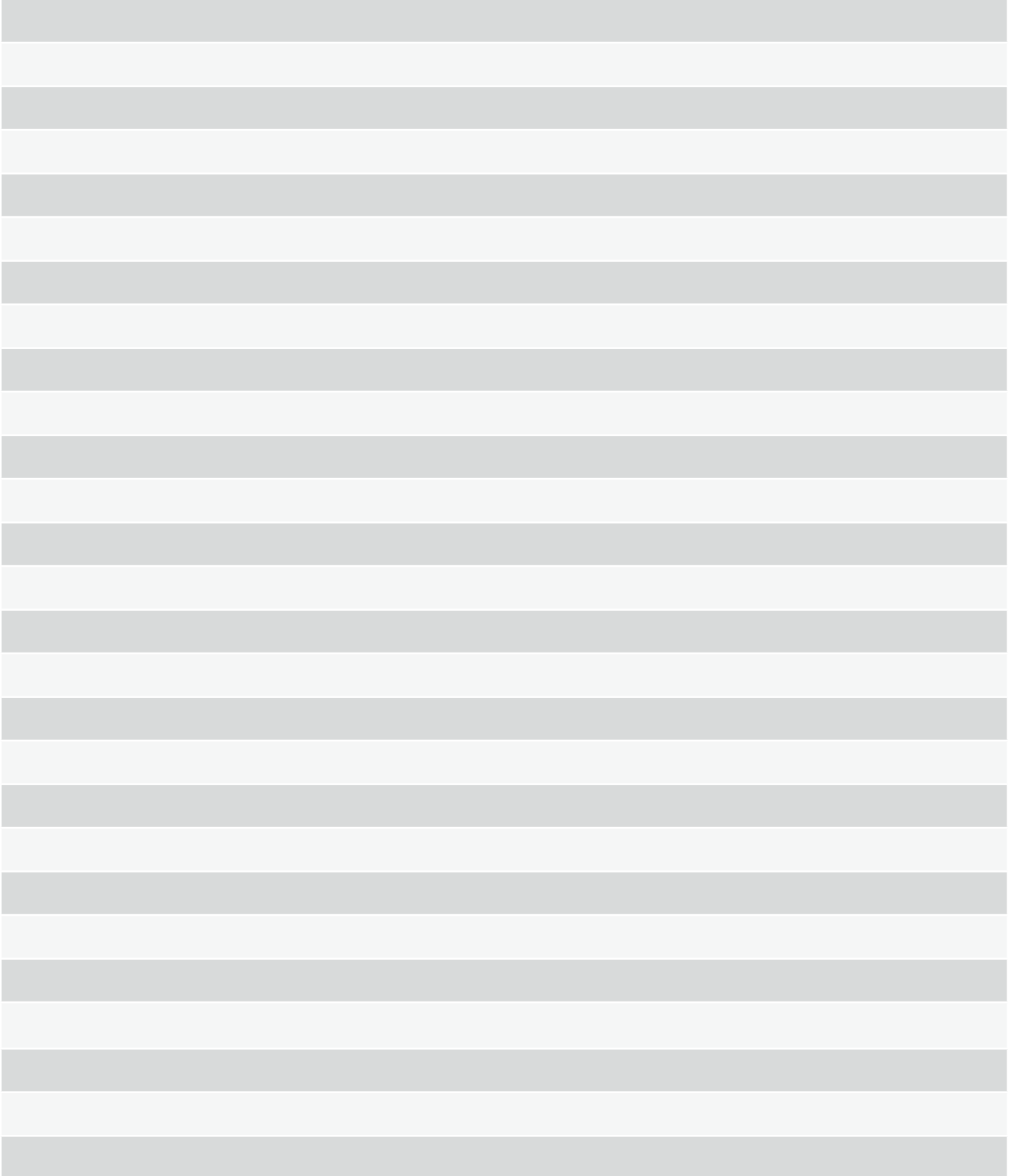

Sicherungen für fast alle Einsatzzwecke / Fuses for nearly all purposes
Übersicht über das SIBA Gesamtprogramm / Overview complete portfolio SIBA



Hauptsitz / Head Office

SIBA GmbH

Borker Straße 20-22
D-44534 Lünen
Postfach 1940
D-44509 Lünen
Tel.: +49-2306-7001-0
Fax: +49-2306-7001-10
info@siba.de
www.siba.de



Deutschland / Germany

SIBA Vertriebsbüro Freiberg

Untergasse 12
D-09599 Freiberg
Tel.: +49-3731-202283
Fax: +49-3731-202462
alexander.kolbe@siba.de

SIBA Vertriebsbüro Rhein/Ruhr

Espelweg 25
D-58730 Fröndenberg
Tel.: +49-2373-1753141
Fax: +49-2373-1753142
joerg.mattusch@siba.de

SIBA Vertriebsbüro Süd-West

Germersheimer Str. 101a
D-67360 Lingenfeld
Tel.: +49-6344-937510
Fax: +49-6344-937511
erwin.leuthner@siba.de

SIBA Vertriebsbüro Kassel

Siebertweg 20
D-34225 Baunatal
Tel.: +49-5601-965300
Fax: +49-5601-965301
achim.fischer@siba.de

SIBA Vertriebsbüro Bayern

Kirchstraße 12
D-86316 Friedberg
Tel.: +49-821-58955260
Fax: +49-821-58955261
guenther.heinz@siba.de

International

SIBA Sicherungen- und Schalterbau Ges.m.b.H & Co. KG (Austria)

Ortsstraße 18 · A-2331 Vösendorf bei Wien
Tel.: +43-1-6994053 und 6992592
Fax: +43-1-699405316 und 699259216
info.siba@aon.at
www.siba-sicherungen.at

SIBA GmbH Beijing Rep. Office (China)

Rm 1609, Block B, Lucky Tower
No. 3, Dongsanhuan Beilu, Chaoyang district
Beijing 100027
Tel.: +86-10-65817776
Fax: +86-10-64686648
siba_china@sibafuse.cn
www.sibafuse.cn

SIBA Písek s.r.o. (Czech Rep.)

U Vodárny 1506 · 397 01 Písek
Tel.: +420-38-2265746
Fax: +420-38-2265746
sibacz@iol.cz · www.siba-pojistky.cz

SIBA Sikringer Danmark A/S (Denmark)

Lunikvej 24 B
DK-2670 Greve
Tel.: +45-86828175 · Fax: +45-86814565
info@sikringer.dk · www.siba-sikringer.dk

SIBA Nederland B.V. (Netherlands)

Van Gentstraat 16
NL-5612 KM Eindhoven
Tel.: +31-40-2467071
Fax: +31-40-2439916
info@sibafuses.nl · www.siba-zekeringen.nl

SIBA Polska sp. z o.o. (Poland)

ul. Grzybowa 5G
05-092 Łomianki Dąbrowa Leśna
Tel.: +48-22-8321477
Fax: +48-22-8339118
siba@siba-bezpieczniki.pl
www.siba-bezpieczniki.pl

SIBA Rossija

ul. Petrovka 27
Moskva 107031
Tel.: +7-495-9871413
Fax: +7-495-9871774
info@siba-predohraniteli.ru
www.siba-predohraniteli.ru

SIBA Fuses SA PTY. LTD. (South Africa)

P.O. Box 34261
Jeppesstown 2043
Tel.: +27-11334-6560 / 4
Fax: +27-11334-7140
sibafuses@universe.co.za
www.siba-fuses.co.za

SIBA Far East Pte. LTD. (South East Asia)

24 Sin Ming Lane, # 07 - 105
Midview City, Singapore 573970, Republic of
Singapore
Tel.: +65-66599449
Fax: +65-66594994
sales@sibafuse.com.sg
www.sibafuse.com.sg

SIBA (UK) LTD. (United Kingdom)

19 Duke Street
Loughborough. Leics. LE11 1ED
Tel.: +44-1509-269719
Fax: +44-1509-236024
siba.uk@btconnect.com
www.siba-fuses.co.uk

SIBA Fuses LLC (United States of America)

29 Fairfield Place
West Caldwell, NJ 07006
Tel.: +1-973575-7422 (973-575-SIBA)
Fax: +1-973575-5858
info@sibafuses.com
www.sibafuses.com

**Weitere Vertriebspartner weltweit /
Further distribution partners worldwide:**
www.siba.de / www.siba-fuses.com